

Date:	_____
Project:	_____
Price:	_____

Millennium Magnetic Fixture

Our Millennium Magnetic Fixture is a unique track system that is easily customizable. With the most powerful magnet technology available, this track offers perfect strong adhesion finishing. The straight or curved track offers a large assortment of fixture attachments for offices, retail, lobbies, and showroom spaces.



Features:

- Mounting: Recessed, Suspended or Surface mounted.
- Finish: Matte Black, Matte White
- Multiple attachment options: Down Direct, Linear, Fold, Out, Wall Washers, Spot, Pendant, and Ring
- Multiple diffuser options
- CRI >90
- IP20
- L70 Lifetime: 60,000 hours.
- Operating temperature: -40°F to 176°F.
- 7 Year Warranty

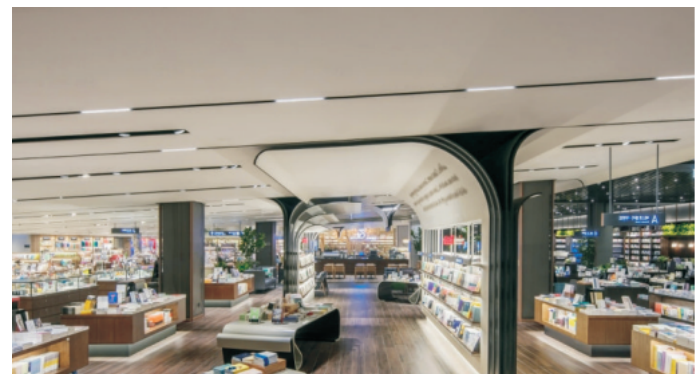

Date:	_____
Project:	_____
Price:	_____

Track Rail:

- Magnet: NdFeB rare-earth permanent magnet
- Mounting: Recessed, Suspended or Surface mounted.
- Material: Aluminum
- Shape option: Straight, recessed straight, curvy, mini trim straight
- Length: 39.25", 78.6", 118", or customized
- Width: 1.5" (standard) or 1" (mini)
- Seamless connection
- Input: DC24V

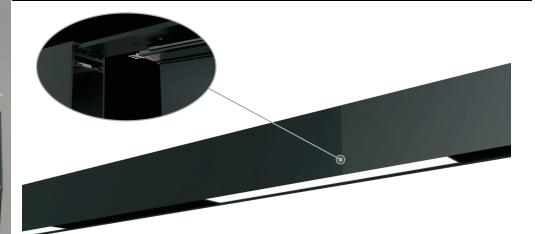

Accessories:

Pendant kit-A

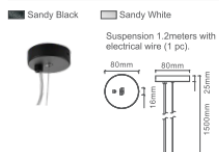

Pendant kit-B

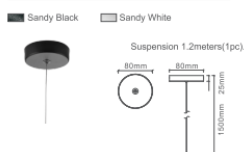

Pendant kit-C

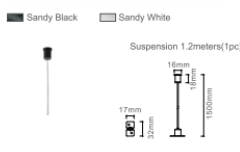

Track connector



Power plate 65mm

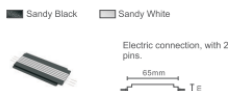

Pin



Track cover



Track driver box



Driver box



End cap



New surface mounted kits



Recessed kit



NdFeB N35 rare-earth permanent magnet, 3600 (~10%) Gauss

Excellent powder coating

L Corner-R

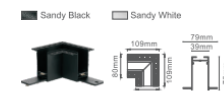

Inner Corner-R

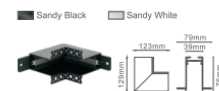

Outer Corner-R

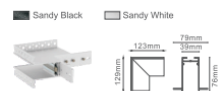

T Corner-R

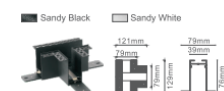

Date: _____
 Project: _____
 Price: _____

Straight Track Rail:



Model	Power	Install	Length
1 Meter profile	200W max	Surface/Pendant/Recessed	1000mm
2 Meter profile	200W max	Surface/Pendant/Recessed	2000mm
3 Meter profile	200W max	Surface/Pendant/Recessed	3000mm

■ Sandy Black □ Sandy White ■ Golden ■ Black bronze

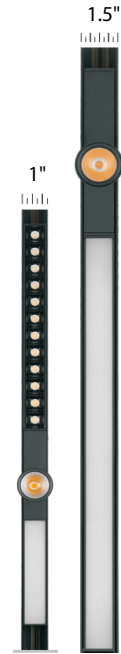
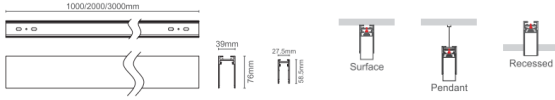

Accessories:

CORNER

L Corner

■ Sandy Black □ Sandy White

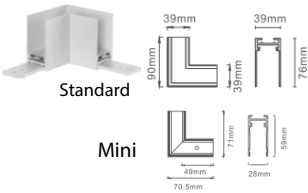

Inner Corner

■ Sandy Black □ Sandy White

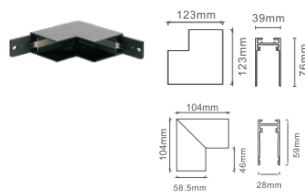

Outer Corner

■ Sandy Black □ Sandy White

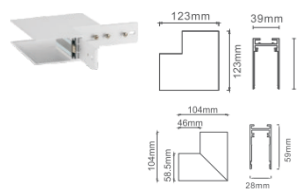

T corner

■ Sandy Black □ Sandy White

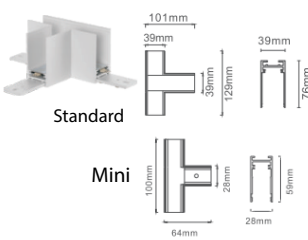

45D corner

■ Sandy Black □ Sandy White

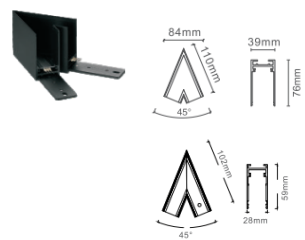

CROSS corner

■ Sandy Black □ Sandy White

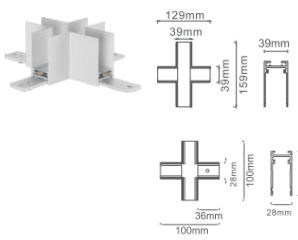

POWER FEED

Input terminal

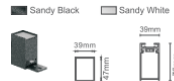

Trim Recessed Track Rail:

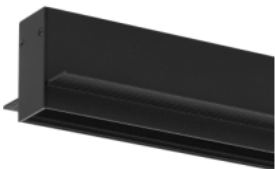

Model	Power	Install	Length
1 Meter profile-M-s	200W max	Recessed	1000mm
2 Meter profile-M-s	200W max	Recessed	2000mm
3 Meter profile-M-s	200W max	Recessed	3000mm

■ Sandy Black □ Sandy White



CORNER

L Corner-M-s

■ Sandy Black □ Sandy White

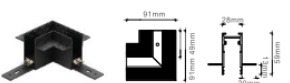

Inner Corner-M-s

■ Sandy Black □ Sandy White

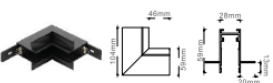

Outer Corner-M-s

■ Sandy Black □ Sandy White

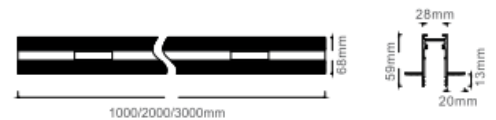
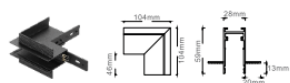

Date: _____
 Project: _____
 Price: _____

Curvy Track Rail:

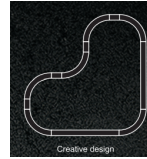

Power: 200W max
 Install: Surface/Pendant/Recessed

Color options: Sandy Black, Sandy White, Golden, Black bronze



	Ring	Half Ring	Quarter Ring	Smallest Ring
Standard				
Mini				

Trimless Recessed Track Rail:



Model	Power	Install	Length
1 Meter profile-R	200W max	Recessed	1000mm
2 Meter profile-R	200W max	Recessed	2000mm
3 Meter profile-R	200W max	Recessed	3000mm

Color options: Sandy Black, Sandy White

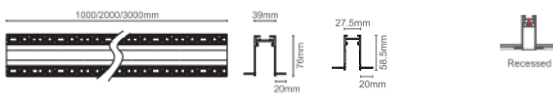

Accessories:

CORNER

L Corner-R	Inner Corner-R	Outer Corner-R
Standard		
Mini		

T Corner-R

Standard	Mini

POWER FEED

Input terminal-R

Standard	Mini

Date:	_____
Project:	_____
Price:	_____

Dual Track Rail 1 (Short):



Model	Power	Install	Length
1 Meter profile	200W max	Surface/Pendant/Recessed	1000mm
2 Meter profile	200W max	Surface/Pendant/Recessed	2000mm
3 Meter profile	200W max	Surface/Pendant/Recessed	3000mm

Sandy Black
 Sandy White
 Golden
 Black bronze

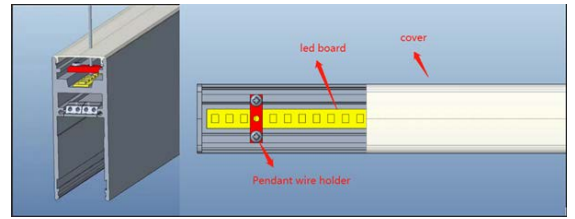
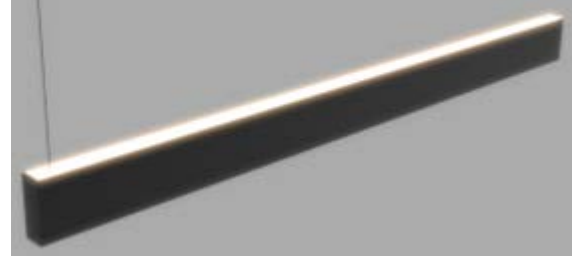
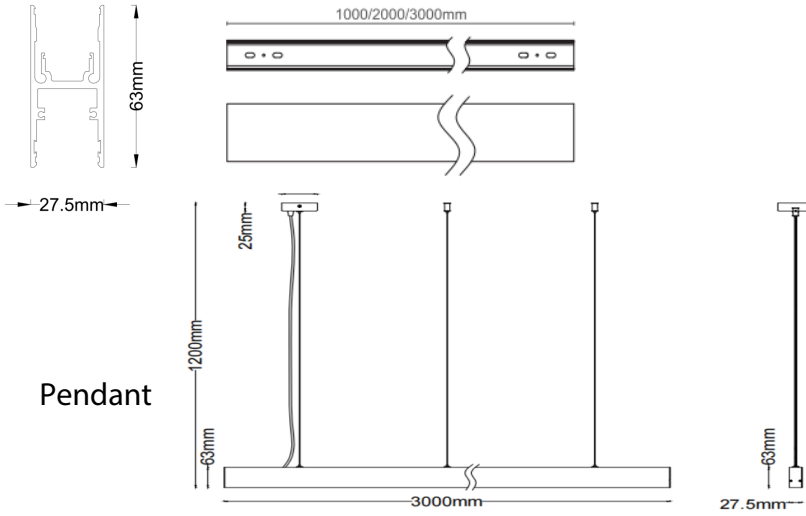

Dual Track Rail 2 (High):



Model	Power	Install	Length
1 Meter profile	200W max	Surface/Pendant/Recessed	1000mm
2 Meter profile	200W max	Surface/Pendant/Recessed	2000mm
3 Meter profile	200W max	Surface/Pendant/Recessed	3000mm

Sandy Black
 Sandy White
 Golden
 Black bronze

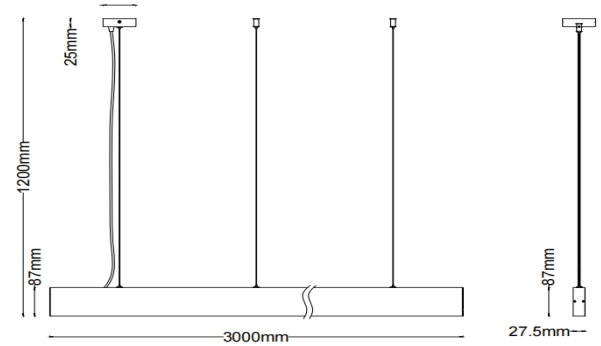
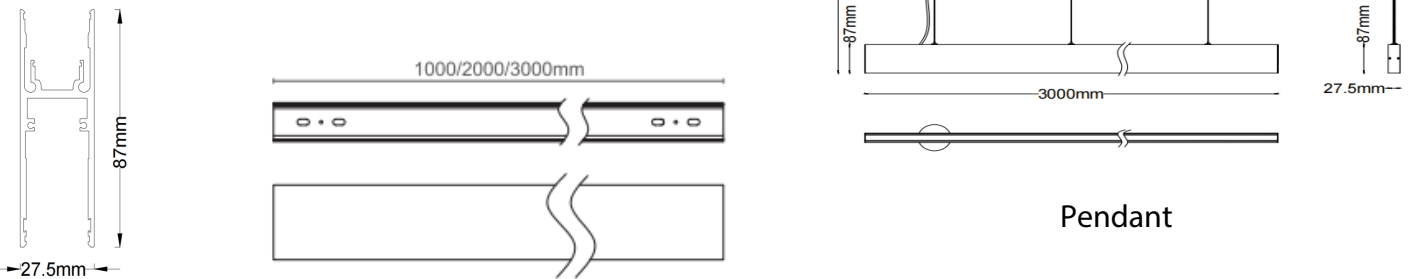

Pendant

Date: _____
 Project: _____
 Price: _____

Track Head: Down Direct Series:

D1



POWER	CRI	SDCM	CCT	BEAM	LUMINOUS FLUX
2W	> 90	< 3	3000K	12°	126Lm
	> 80		2700K	34°	
			4000K	48°	

■ Sandy Black □ Sandy White



D6



POWER	CRI	SDCM	CCT	BEAM	LUMINOUS FLUX
4W	> 90	< 3	3000K	12°	382Lm
	> 80		2700K	34°	
			4000K	48°	

■ Sandy Black □ Sandy White

LIGHT DISTRIBUTION 3000K 90Ra

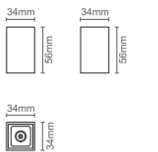
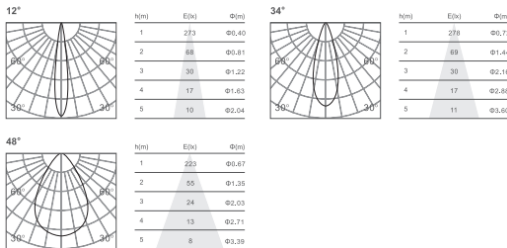

LIGHT DISTRIBUTION 3000K 90Ra

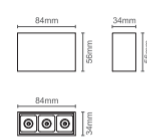
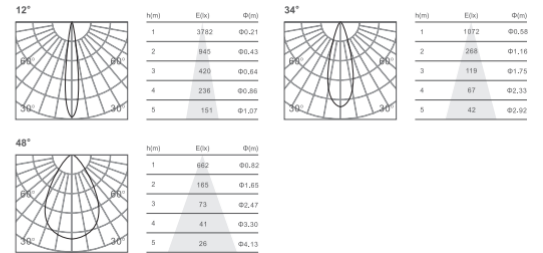

D3



POWER	CRI	SDCM	CCT	BEAM	LUMINOUS FLUX
8W	> 90	< 3	3000K	12°	733Lm
	> 80		2700K	34°	
			4000K	48°	

■ Sandy Black □ Sandy White



LIGHT DISTRIBUTION 3000K 90Ra

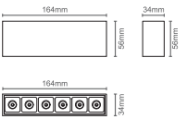
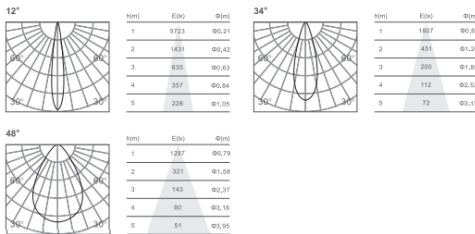

D12



POWER	CRI	SDCM	CCT	BEAM	LUMINOUS FLUX
16W	> 90	< 3	3000K	12°	1440Lm
	> 80		2700K	34°	
			4000K	48°	

■ Sandy Black □ Sandy White

LIGHT DISTRIBUTION 3000K 90Ra

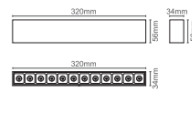
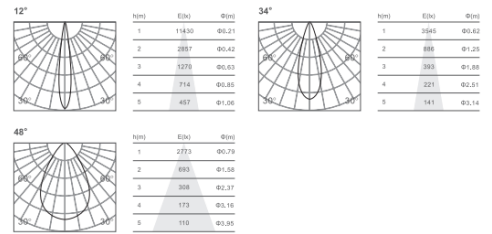



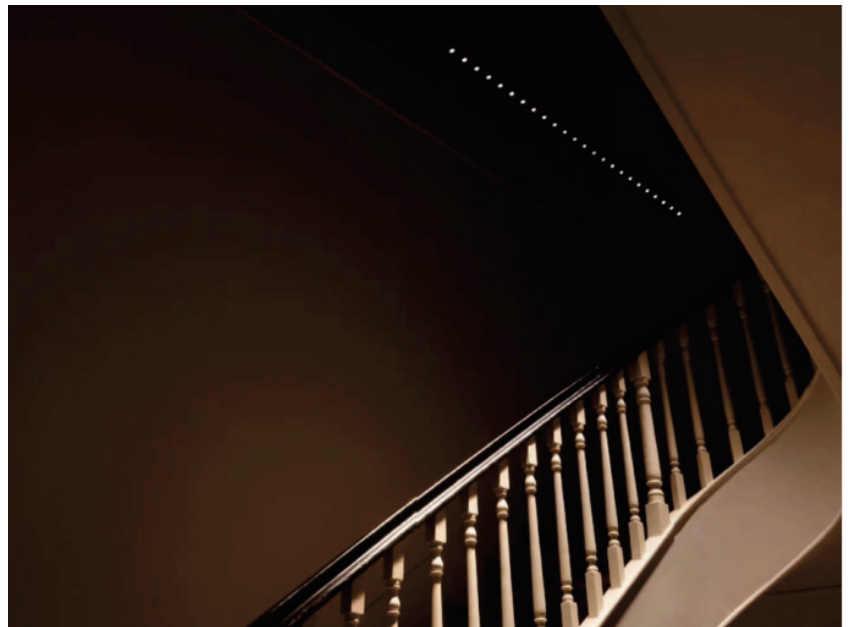

Image	Item #	Length	Wattage	Lumen
	D1	34mm	2W	120LM
	D3	84mm	4W	380LM
	D6	164mm	8W	790LM
	D12	324mm	16W	1550LM



Date: _____
 Project: _____
 Price: _____

Linear Series:

- Diffuse lens
- Color Temperature: 2700K, 3000K, 4000K
- CRI: >90
- Color finish: Matte White, Matte Black



Linear8



POWER	CRI	SDCM	CCT	BEAM	LUMINOUS FLUX
4W	> 90 > 80	< 3	3000K 2700K 4000K	Diffuse	223Lm

■ Sandy Black □ Sandy White

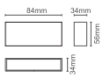

LIGHT DISTRIBUTION

3000K 90Ra

Diffuse

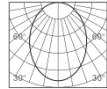

h(m)	E(h)	θ(h)
1	88	02.38
2	22	04.77
3	9	07.16
4	5	09.55
5	3	11.94



Linear16



POWER	CRI	SDCM	CCT	BEAM	LUMINOUS FLUX
7W	> 90 > 80	< 3	3000K 2700K 4000K	Diffuse	488Lm

■ Sandy Black □ Sandy White



LIGHT DISTRIBUTION

3000K 90Ra

Diffuse

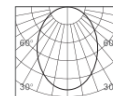

h(m)	E(h)	θ(h)
1	189	02.48
2	47	04.95
3	21	07.42
4	11	09.89
5	7	12.36



Linear32



POWER	CRI	SDCM	CCT	BEAM	LUMINOUS FLUX
13W	> 90 > 80	< 3	3000K 2700K 4000K	Diffuse	895Lm

■ Sandy Black □ Sandy White



LIGHT DISTRIBUTION

3000K 90Ra

Diffuse

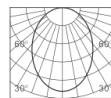

h(m)	E(h)	θ(h)
1	384	02.47
2	66	04.94
3	38	07.41
4	21	09.88
5	13	12.35



Linear64



POWER	CRI	SDCM	CCT	BEAM	LUMINOUS FLUX
26W	> 90 > 80	< 3	3000K 2700K 4000K	Diffuse	1720Lm

■ Sandy Black □ Sandy White

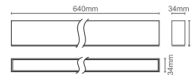

LIGHT DISTRIBUTION

3000K 90Ra

Diffuse

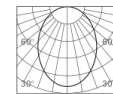

h(m)	E(h)	θ(h)
1	661	02.47
2	165	04.94
3	73	07.41
4	41	09.88
5	26	12.36

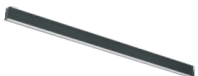

Linear96



POWER	CRI	SDCM	CCT	BEAM	LUMINOUS FLUX
39W	> 90 > 80	< 3	3000K 2700K 4000K	Diffuse	2550Lm

■ Sandy Black □ Sandy White

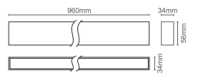

LIGHT DISTRIBUTION

3000K 90Ra

Diffuse

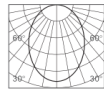

h(m)	E(h)	θ(h)
1	962	02.33
2	240	04.66
3	107	07.00
4	60	09.33
5	38	11.66



Tube



POWER	CRI	SDCM	CCT	BEAM	LUMINOUS FLUX
16W	> 90 > 80	< 3	3000K 2700K 4000K	Diffuse	1270Lm

■ Sandy Black □ Sandy White

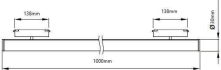

Date: _____
 Project: _____
 Price: _____

Fold Series:



Fold03



POWER	CRI	SDCM	CCT	BEAM	LUMINOUS FLUX
4W	> 90	< 3	3000K	12°	382Lm
	> 80		2700K	34°	
			4000K	48°	

■ Sandy Black □ Sandy White



Fold06



POWER	CRI	SDCM	CCT	BEAM	LUMINOUS FLUX
8W	> 90	< 3	3000K	12°	733Lm
	> 80		2700K	34°	
			4000K	48°	

■ Sandy Black □ Sandy White

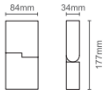

LIGHT DISTRIBUTION

3000K 90Ra

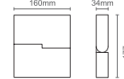
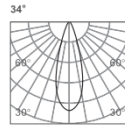
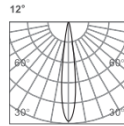

LIGHT DISTRIBUTION

3000K 90Ra

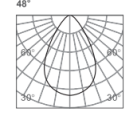
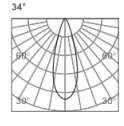
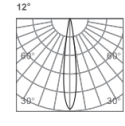

Fold12



POWER	CRI	SDCM	CCT	BEAM	LUMINOUS FLUX
16W	> 90	< 3	3000K	12°	1440LM
	> 80		2700K	34°	
			4000K	48°	

■ Sandy Black □ Sandy White



Fold08



POWER	CRI	SDCM	CCT	BEAM	LUMINOUS FLUX
4W	> 90	< 3	3000K	Diffuse	223Lm
	> 80		2700K		
			4000K		

■ Sandy Black □ Sandy White

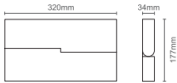

LIGHT DISTRIBUTION

3000K 90Ra

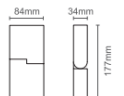
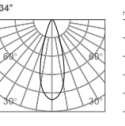
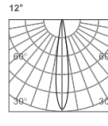

LIGHT DISTRIBUTION

3000K 90Ra

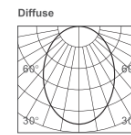

h(m)	E(lx)	Φ(m)
1	88	Φ2.38
2	22	Φ4.77
3	9	Φ7.16
4	5	Φ9.55
5	3	Φ11.94

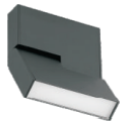

Fold16



POWER	CRI	SDCM	CCT	BEAM	LUMINOUS FLUX
8W	> 90	< 3	3000K	Diffuse	488Lm
	> 80		2700K		
			4000K		

■ Sandy Black □ Sandy White



Fold32



POWER	CRI	SDCM	CCT	BEAM	LUMINOUS FLUX
16W	> 90	< 3	3000K	Diffuse	1270Lm
	> 80		2700K		
			4000K		

■ Sandy Black □ Sandy White

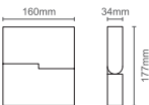

LIGHT DISTRIBUTION

3000K 90Ra

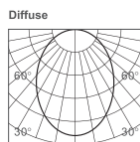

h(m)	E(lx)	Φ(m)
1	189	Φ2.46
2	47	Φ4.92
3	21	Φ7.38
4	11	Φ9.84
5	7	Φ12.30

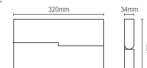

LIGHT DISTRIBUTION

3000K 90Ra

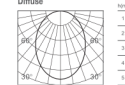

Date: _____
Project: _____
Price: _____

Out Series:

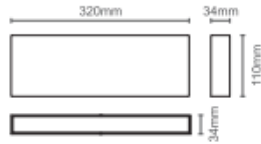

Out32



POWER	CRI	SDCM	CCT	BEAM	LUMINOUS FLUX
13W	> 90 > 80	< 3	3000K 2700K 4000K	Diffuse	895Lm

■ Sandy Black □ Sandy White

LIGHT DISTRIBUTION
3000K 90Ra

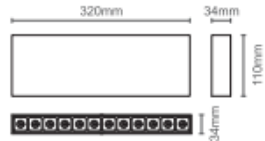
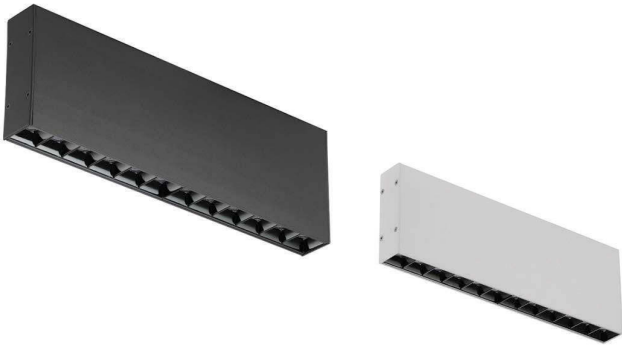
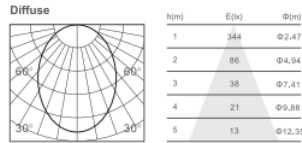

Out12



POWER	CRI	SDCM	CCT	BEAM	LUMINOUS FLUX
16W	> 90 > 80	< 3	3000K 2700K 4000K	12° 34° 48°	1435Lm

■ Sandy Black □ Sandy White

LIGHT DISTRIBUTION
3000K 90Ra

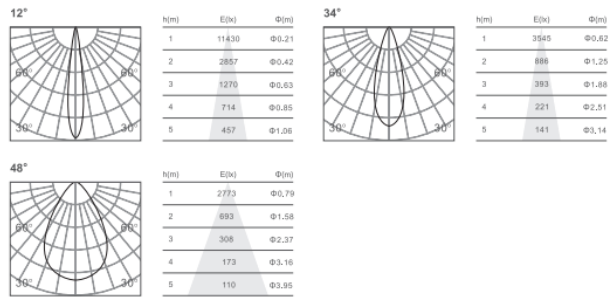

Date:	_____
Project:	_____
Price:	_____

Wallwasher Series:



Washer13



POWER	CRI	SDCM	CCT	BEAM	LUMINOUS FLUX
8W	> 90 > 80	< 3	3000K 2700K 4000K	wallwasher	480Lm

■ Sandy Black □ Sandy White

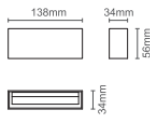

LIGHT DISTRIBUTION

3000K 90Ra

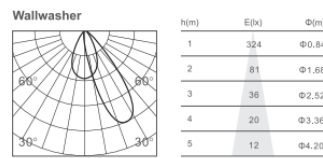

Washer27



POWER	CRI	SDCM	CCT	BEAM	LUMINOUS FLUX
16W	> 90 > 80	< 3	3000K 2700K 4000K	wallwasher	1055Lm

■ Sandy Black □ Sandy White

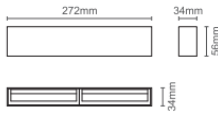

LIGHT DISTRIBUTION

3000K 90Ra

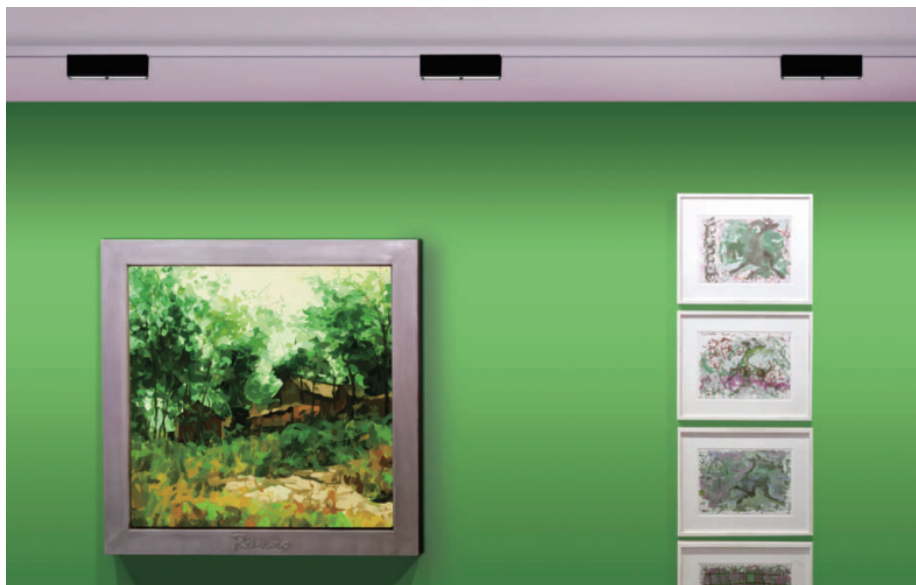
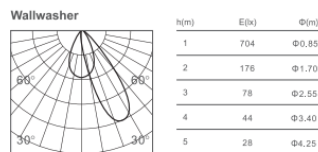

Date: _____
 Project: _____
 Price: _____

Spot Series:



Spot35



POWER	CRI	SDCM	CCT	BEAM	LUMINOUS FLUX
5W	> 90	< 3	3000K	20°	526Lm
	> 80		2700K	30°	
			4000K	40°	

STANDARD

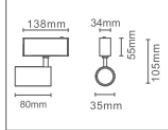

■ Sandy Black □ Sandy White ■ Golden

LIGHT DISTRIBUTION

3000K 90Ra

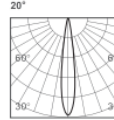

h[m]	E[lx]	Φ[m]
1	3184	Φ0.34
2	786	Φ0.68
3	349	Φ1.02
4	196	Φ1.36
5	125	Φ1.71

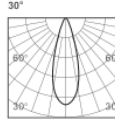

h[m]	E[lx]	Φ[m]
1	3151	Φ0.36
2	780	Φ0.72
3	348	Φ1.08
4	195	Φ1.45
5	124	Φ1.81

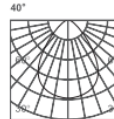

h[m]	E[lx]	Φ[m]
1	1863	Φ0.43
2	466	Φ0.87
3	218	Φ1.30
4	122	Φ1.74
5	78	Φ2.17

STANDARD CURVY

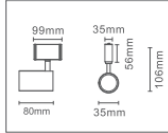

Spot35-T



POWER	CRI	SDCM	CCT	BEAM	LUMINOUS FLUX
2x5W	> 90	< 3	3000K	20°	526Lm
	> 80		2700K	30°	
			4000K	40°	

■ Sandy Black □ Sandy White ■ Golden

LIGHT DISTRIBUTION

3000K 90Ra

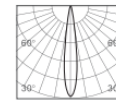

h[m]	E[lx]	Φ[m]
1	3166	Φ0.34
2	786	Φ0.68
3	349	Φ1.02
4	196	Φ1.36
5	125	Φ1.71

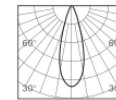

h[m]	E[lx]	Φ[m]
1	3151	Φ0.36
2	780	Φ0.72
3	348	Φ1.08
4	195	Φ1.45
5	124	Φ1.81

STANDARD

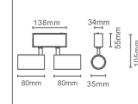

STANDARD CURVY

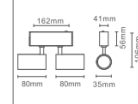

Spot50



POWER	CRI	SDCM	CCT	BEAM	LUMINOUS FLUX
10W	> 90	< 3	3000K	18°	682Lm
	> 80		2700K	24°	
			4000K	36°	

■ Sandy Black □ Sandy White ■ Golden

STANDARD

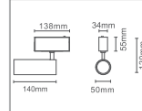

LIGHT DISTRIBUTION

3000K 90Ra

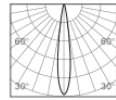

h[m]	E[lx]	Φ[m]
1	4902	Φ0.32
2	1226	Φ0.65
3	544	Φ0.98
4	306	Φ1.31
5	196	Φ1.65

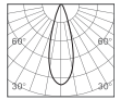

h[m]	E[lx]	Φ[m]
1	4186	Φ0.39
2	1047	Φ0.79
3	465	Φ1.19
4	261	Φ1.58
5	167	Φ1.98

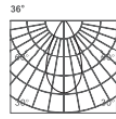

h[m]	E[lx]	Φ[m]
1	2677	Φ0.54
2	119	Φ1.29
3	230	Φ1.94
4	129	Φ2.58
5	83	Φ3.23

STANDARD CURVY

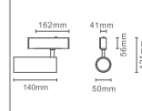

Spot70



POWER	CRI	SDCM	CCT	BEAM	LUMINOUS FLUX
20W	> 90	< 3	3000K	18°	1343Lm
	> 80		2700K	24°	
			4000K	36°	

■ Sandy Black □ Sandy White

STANDARD

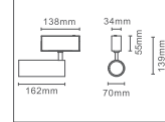

LIGHT DISTRIBUTION

3000K 90Ra

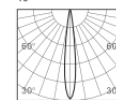

h[m]	E[lx]	Φ[m]
1	982	Φ0.30
2	236	Φ0.61
3	107	Φ0.91
4	56	Φ1.22
5	36	Φ1.52

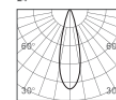

h[m]	E[lx]	Φ[m]
1	589	Φ0.46
2	148	Φ0.93
3	62	Φ1.39
4	31	Φ1.86
5	22	Φ2.32

STANDARD CURVY

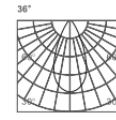
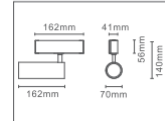

h[m]	E[lx]	Φ[m]
1	342	Φ0.68
2	86	Φ1.37
3	38	Φ2.06
4	24	Φ2.75
5	13	Φ3.44



Zoom55



POWER	CRI	SDCM	CCT	BEAM	LUMINOUS FLUX
10W	> 90	< 3	3000K	20°-60°	800Lm
	> 80		2700K		
			4000K		

■ Sandy Black □ Sandy White

STANDARD

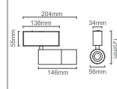

LIGHT DISTRIBUTION

3000K 90Ra

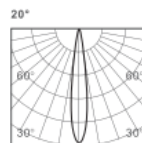

h[m]	E[lx]	Φ[m]
1	4510	Φ0.40
2	1127	Φ0.80
3	501	Φ1.21
4	281	Φ1.61
5	182	Φ2.02

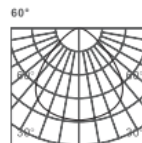

h[m]	E[lx]	Φ[m]
1	568	Φ1.09
2	242	Φ2.18
3	107	Φ3.27
4	60	Φ4.36
5	38	Φ5.45

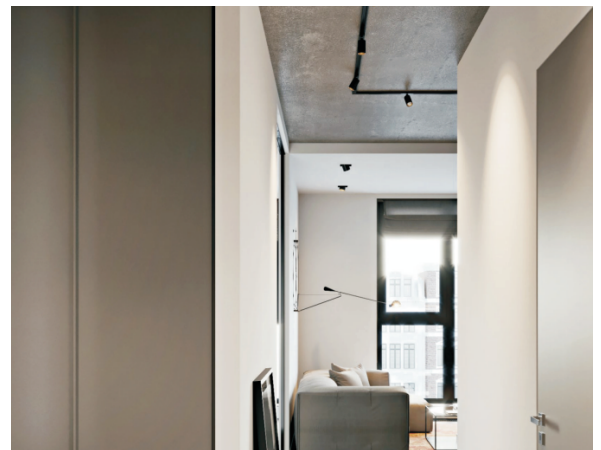
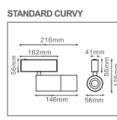

Date: _____
 Project: _____
 Price: _____

Spot Series:

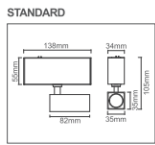

Spot35-SQ



POWER	CRI	SDCM	CCT	BEAM	LUMINOUS FLUX
8W	> 90	< 3	3000K	15°	365Lm
	> 80		2700K		
			4000K		

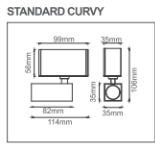

■ Sandy Black □ Sandy White

LIGHT DISTRIBUTION

3000K 90Ra

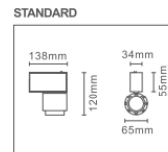
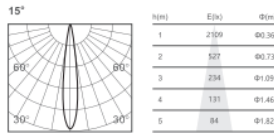

Spot65-R



POWER	CRI	SDCM	CCT	BEAM	LUMINOUS FLUX
8W	> 90	< 3	3000K	10°	251Lm
	> 80		2700K	20°	
			4000K	30°	

■ Sandy Black □ Sandy White

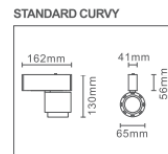

LIGHT DISTRIBUTION

3000K 90Ra

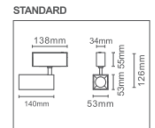
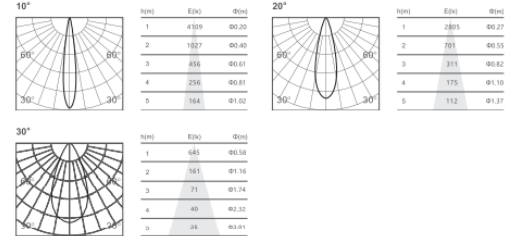

Spot50-SQ



POWER	CRI	SDCM	CCT	BEAM	LUMINOUS FLUX
10W	> 90	< 3	3000K	18°	688Lm
	> 80		2700K	24°	
			4000K	36°	

■ Sandy Black □ Sandy White

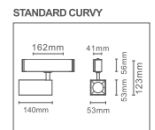

LIGHT DISTRIBUTION

3000K 90Ra

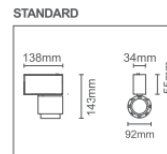
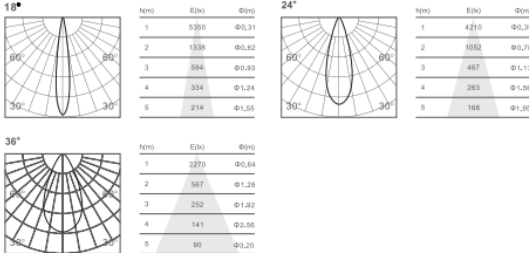

Spot92-R



POWER	CRI	SDCM	CCT	BEAM	LUMINOUS FLUX
15W	> 90	< 3	3000K	10°	481Lm
	> 80		2700K	20°	
			4000K	30°	

■ Sandy Black □ Sandy White

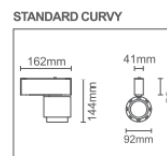

LIGHT DISTRIBUTION

3000K 90Ra

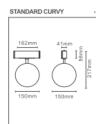
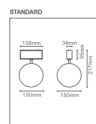
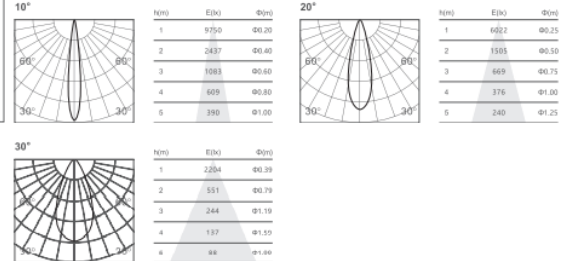

Global



POWER	CRI	SDCM	CCT	BEAM	LUMINOUS FLUX
5W	> 90	< 3	3000K	Diffuse	346Lm
	> 80		2700K		
			4000K		

■ Sandy Black □ Sandy White

LIGHT DISTRIBUTION

2700K 90Ra

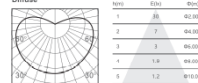

Date: _____
 Project: _____
 Price: _____

Pendant Series:



Pendant35-R



POWER	CRI	SDCM	CCT	BEAM	LUMINOUS FLUX
5W	> 90	< 3	3000K	20°	526Lm
	> 80		2700K	30°	
			4000K	40°	

■ Sandy Black □ Sandy White ■ Golden ■ Black bronze

LIGHT DISTRIBUTION

3000K 90Ra

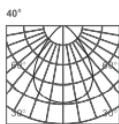
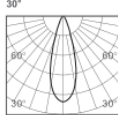
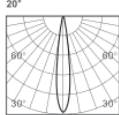

Pendant50-R



POWER	CRI	SDCM	CCT	BEAM	LUMINOUS FLUX
10W	> 90	< 3	3000K	18°	682Lm
	> 80		2700K	24°	
			4000K	36°	

■ Sandy Black □ Sandy White ■ Golden ■ Black bronze

LIGHT DISTRIBUTION

3000K 90Ra

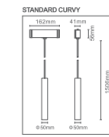
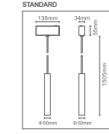
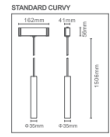
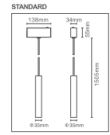
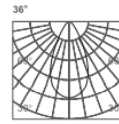
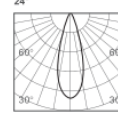
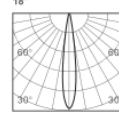

Pendant35-R-A-10



POWER	CRI	SDCM	CCT	BEAM	LUMINOUS FLUX
5W	> 90	< 3	3000K	20°	460Lm
	> 80		2700K		
			4000K		

■ Sandy Black □ Sandy White ■ Golden ■ Black bronze

LIGHT DISTRIBUTION

3000K 90Ra

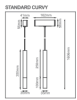
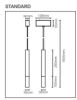
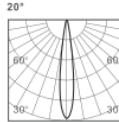

Pendant35-R-A-20



POWER	CRI	SDCM	CCT	BEAM	LUMINOUS FLUX
5W	> 90	< 3	3000K	20°	460Lm
	> 80		2700K		
			4000K		

■ Sandy Black □ Sandy White ■ Golden ■ Black bronze

LIGHT DISTRIBUTION

3000K 90Ra

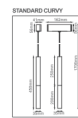
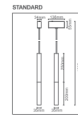
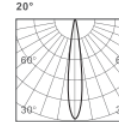

Pendant-glory



POWER	CRI	SDCM	CCT	BEAM	LUMINOUS FLUX
10W	> 90	< 3	3000K	Diffuse	264Lm
	> 80		2700K		
			4000K		

■ Sandy Black □ Sandy White

LIGHT DISTRIBUTION

3000K 90Ra

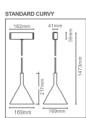
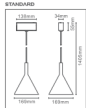
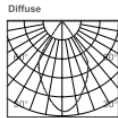

Pendant-global



POWER	CRI	SDCM	CCT	BEAM	LUMINOUS FLUX
5W	> 90	< 3	3000K	Diffuse	346Lm
	> 80		2700K		
			4000K		

■ Sandy Black □ Sandy White

LIGHT DISTRIBUTION

2700K 90Ra

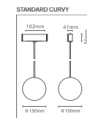
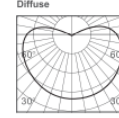

Pendant-Round/Hex



POWER	CRI	SDCM	CCT	BEAM	LUMINOUS FLUX
39W	> 90	< 3	3000K	Diffuse	2550Lm
	> 80		2700K		
			4000K		

■ Sandy Black □ Sandy White

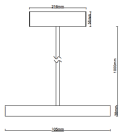

Date: _____
 Project: _____
 Price: _____

Ring Series:



Ring-D12

DC24V INPUT 

POWER	CRI	SDCM	CCT	BEAM	LUMINOUS FLUX
12W	> 90	< 3	3000K	20°	950Lm
	> 80		2700K	34°	
			4000K	48°	

■ Sandy Black □ Sandy White

LIGHT DISTRIBUTION
3000K 90Ra

20°

h(m)	E(lx)	Φ(m)
1	4033	00.42
2	1008	00.84
3	448	01.26
4	252	01.68
5	161	02.10

34°

h(m)	E(lx)	Φ(m)
1	2787	00.57
2	696	01.15
3	309	01.72
4	174	02.30
5	111	02.88

48°

h(m)	E(lx)	Φ(m)
1	1634	00.85
2	351	01.70
3	156	02.55
4	87	03.41
5	56	04.26

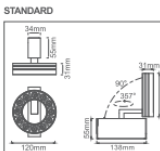
STANDARD 

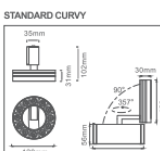
STANDARD CURVE 

Ring-L12

DC24V INPUT 

POWER	CRI	SDCM	CCT	BEAM	LUMINOUS FLUX
12W	> 90	< 3	3000K	Diffuse	470Lm
	> 80		2700K		
			4000K		

■ Sandy Black □ Sandy White

LIGHT DISTRIBUTION
3000K 90Ra

Diffuse

h(m)	E(lx)	Φ(m)
1	182	02.28
2	48	04.53
3	21	06.80
4	12	09.07
5	7	011.34

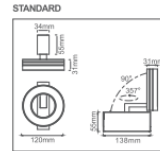
STANDARD 

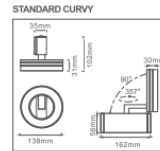
STANDARD CURVE 

Ring-D18

DC24V INPUT 

POWER	CRI	SDCM	CCT	BEAM	LUMINOUS FLUX
18W	> 90	< 3	3000K	20°	1562Lm
	> 80		2700K	34°	
			4000K	48°	

■ Sandy Black □ Sandy White

LIGHT DISTRIBUTION
3000K 90Ra

20°

h(m)	E(lx)	Φ(m)
1	769	00.39
2	197	00.78
3	852	01.17
4	479	01.57
5	306	01.96

34°

h(m)	E(lx)	Φ(m)
1	447	00.57
2	112	01.14
3	489	01.71
4	275	02.28
5	179	02.85

48°

h(m)	E(lx)	Φ(m)
1	2516	00.83
2	379	01.66
3	257	02.49
4	144	03.32
5	92	04.15

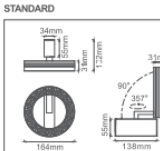
STANDARD 

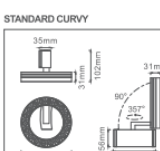
STANDARD CURVE 

Ring-L18

DC24V INPUT 

POWER	CRI	SDCM	CCT	BEAM	LUMINOUS FLUX
18W	> 90	< 3	3000K	Diffuse	686Lm
	> 80		2700K		
			4000K		

■ Sandy Black □ Sandy White

LIGHT DISTRIBUTION
3000K 90Ra

Diffuse

h(m)	E(lx)	Φ(m)
1	270	02.41
2	67	04.83
3	30	07.25
4	16	09.66
5	10	012.08

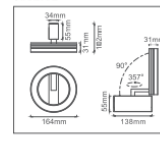
STANDARD 

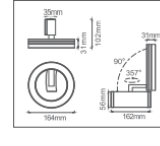
STANDARD CURVE 



Date:	_____
Project:	_____
Price:	_____

Ordering Key:

TRACK RAIL:

ILTLMMVD

SERIES NUMBER	TRACK	WIDTH	LENGTH	MOUNTING	COLOR FINISH
ILTLMMVD	1TC - Curvy	S - Standard	R - Ring	S - Surface	W - White
		M - Mini	H - Half Ring	P - Pendent	B - Black
			Q - Quarter Ring	R - Recssed	
			S - Smallest Ring		
	2TR - Trimless Recessed Straight*		3F - 3.3FT		
	3TS - Straight		6F - 6.6FT		
	4TT - Trim Recessed Straight*		10F - 9.8FT		
	5TD1 - Short Dual Track**		xF - Customized lenght		
	5TD2 - High Dual Track**				

SAMPLE ITEM NUMBER: ILPFMMVD 3TS 3F S B *Only available for recessed installation **Only available in mini width and pendent amounting

TRACK RAIL ACCESORIES:

ILVDAC

SERIES NUMBER	TRACK	WIDTH	ACCESSORIES OPTION	COLOR FINISH
ILVDAC	1C - Curvy	S - Standard	CRL - L Corner	W - White
	2R - Trimless Recessed	M - Mini	CRI - Inner Corner	B - Black
	3S - Straight		CRO - Outer Corner	
	4T - Trim Recessed**		CRT - T Corner	
	5D1 - Short Dual Track**		CR45 - 45 Degree Corner*	
	5D2 - High Dual Track**		CRC - Cross Corner	
			PK1 - Pendant kit A	
			PK2 - Pendant kit B	
			PK3 - Pendant kit C	
			CN - Track Connector	
			PP - Power Plate	
			IN - Input Terminal	
			TC - Track Cover	
			DB - Driver Box	
			DR80W - 80W Driver	
			DR100W - 100W Driver	
			DR150W -- 150W Driver	
			DR200W -- 200W Driver	
			S - Surface Mount	
			R - Recssed Mount	

SAMPLE ITEM NUMBER: ILVD 2R CRL B *Only Available for straight track **Only Available for mini rail



Date: _____
 Project: _____
 Price: _____

Track Head:

ILTLMMVD

SERIES NUMBER	TRACK	WIDTH	LIGHT STYLE	WATTAGE	CCT	BEAM ANGLE	FINISH	
ILTLMMVD	1C - Curvy	S - Standard	D - Down Direct	2W - D1	27K - 2700K	12 - 12°	W - White	
	2R - Trimless Recessed	M - Mini		4W - D3		35K - 3500K		34 - 34°
	3S - Straight			8W - D6	3K - 3000K	48 - 48°		
	4T - Trim Recessed		L - Linear	16W - D12	4K - 4000K	D - Diffuse		
	5D1 - Short Dual Track			4W - Linear08				
	5D2 - High Dual Track			7W - Linear16				
				13W - Linear32				
				26W - Linear64				
				39W - Linear96				
				16W - Tube				
				F - Fold	4W - Fold03/08*			
					8W - Fold06/16*			
					16W - Fold12/32*			
				O - Out	13W - Out32			
					16W - Out12			
				W - Wallwasher	8W - Washer13			
					16W - Washer27			
				S - Spot	R1 - Spot35			
					R2 - Spot35-T			
					R3 - Spot50			
					R4 - Spot70			
					Z - Zoom55			
					Q8W - Spot35-SQ			
					Q10W - Spot50-SQ			
				S8W - Spot65-R				
				S15W - Spot92-R				
				G5W - Global				
			P - Pendant	1 - Pendant35-R				
				2 - Pendant35-R-A10				
				3 - Pendant35-R-A20				
				4 - Pendant50-R				
				5 - Glory				
				6 - Global				
				7 - Round				
				8 - Hex				
			R - Ring	12W - D12/L12*				
				18W - D18/L18*				

SAMPLE ITEM NUMBER: ILTLMMVD

* First one work with beam angle, and last one works with diffuse



Date:	_____
Project:	_____
Price:	_____

Indirect linear light:

- Input Power: DC 24V
- Beam angle: 115 degree
- 6.7W/ft, 551LM/ft
- Standard diffuser
- Mounting: Suspended.

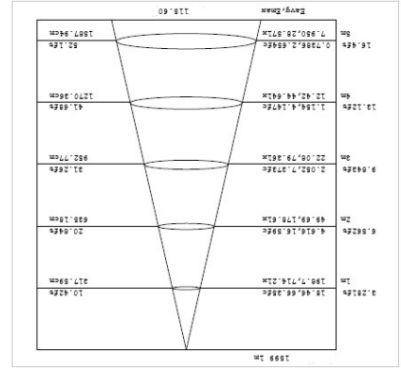
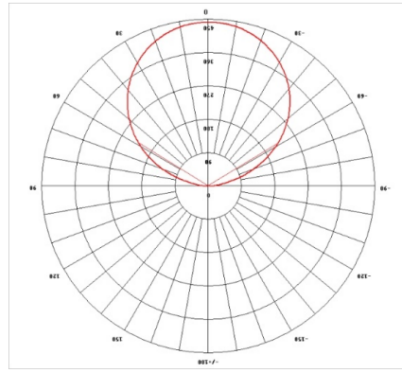

ILTLMMVD

SERIES NUMBER	TRACK	LIGHTING DIRECTION	LENGTH/WATTAGE/LUMEN	CCT	MOUNTING	FINISH	ADDITIONAL OPTIONS
ILTLMMVD	5D1 - Short Dual Track	U - Uplight	3F22W - 3.3FT/1810LM	27K - 2700K	P - Pendant	W - White	EM - Emergency kit
			6F44W - 6.6FT//3620LM	35K - 3500K		B - Black	
	5D2 - High Dual Track		10F66W - 9.8FT/5430LM	3K - 3000K			
			xFxxW - Customized	4K - 4000K			

SAMPLE ITEM NUMBER: ILTLMMVD 5D2 U 6F44W 35K P W

