

Date:	_____
Project:	_____
Price:	_____

# Trey Troffer

## Description:

Our Trey Troffer is a 2x2 or 2x4 recessed troffer easily installed to brighten up any room. Adjustable wattage and CCT options make this fixture perfect for any application, ranging from offices to retail stores.



## Features:

- Input Voltage: AC100-277V, 50/60Hz
- Wattage Adjustable:
  - 2x2: 30W - 35W, 40W
  - 2X4: 30W-40W-50W
- Lumens Output: 110/LM/W
- CRI >90
- CCT Adjustable: 3000K - 3500K - 4000K
- Available Sizes: 2' x 2' or 2' x 4'
- Mounting: Recessed
- 1-10V dimming, Emergency Backup & Sensor option available.
- L70 Lifetime: >50,000 hours
- 7 Year Warranty

## Applications:

- Retail Stores
- Offices
- Schools
- Libraries
- Hospitals
- Gyms



## Dimensions:

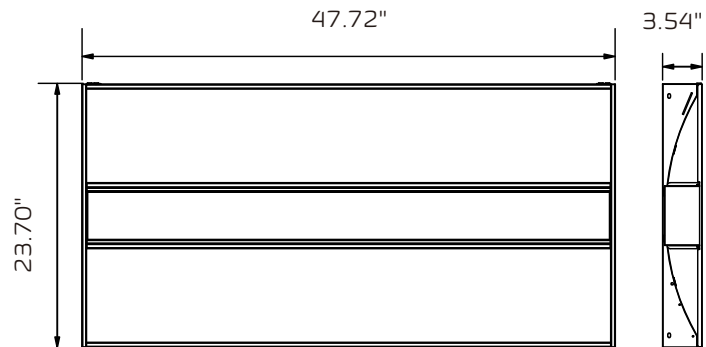
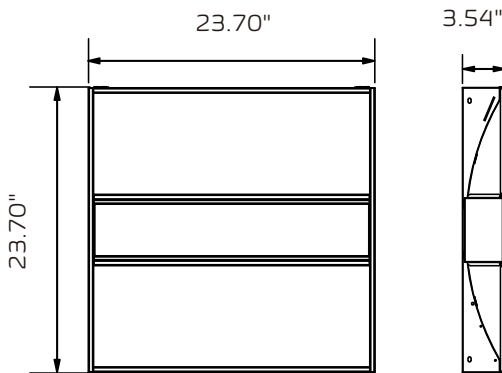

Date:	_____
Project:	_____
Price:	_____

## Ordering Key:

SERIES NUMBER	SIZE	WATTAGE / LUMENS	CCT	ADDITIONAL OPTIONS
ILTRTOK	22 - 2X2	WT1 - TUNEABLE 30W-35W-40W	CCT - TUNEABLE	EM - EMERGENCY BACKUP
	24 - 2X4	WT2 - TUNEABLE 30W-40W-50W		OS - OCCUPANCY SENSOR

SAMPLE ITEM NUMBER: ILTRTOK 22 WT1 CCT EM

## Electrical Data:

- **Input power:** Stays consistent over life
- **Input Voltage:** AC100-277V
- **CRI:** >90
- **Life Expectancy:** ~50,000 hours

## Controls:

- **Sensor:** integrated sensor system for occupancy and daylight dimming control.
- **EM:** Optional low voltage 100-277V emergency LED driver for lighting up to 120 minutes in event of power failure, that meets critical life-safety lighting requirements.

## Optical System:

- A unique combination of reflective & refractive optical components achieves a uniform, comfortable look while eliminating pixelation & color fringing.
- Parts work in unison to optimize light distribution, balancing the high delivery of high illuminance levels on horizontal surfaces with an ideal amount of light on walls and vertical surfaces, increasing perception of spaciousness.





**i-LUMINOSITY**  
LED LIGHTING FIXTURES

Date:	_____
Project:	_____
Price:	_____

## Photometrics 40W:

### Luminous Intensity Distribution Diagram

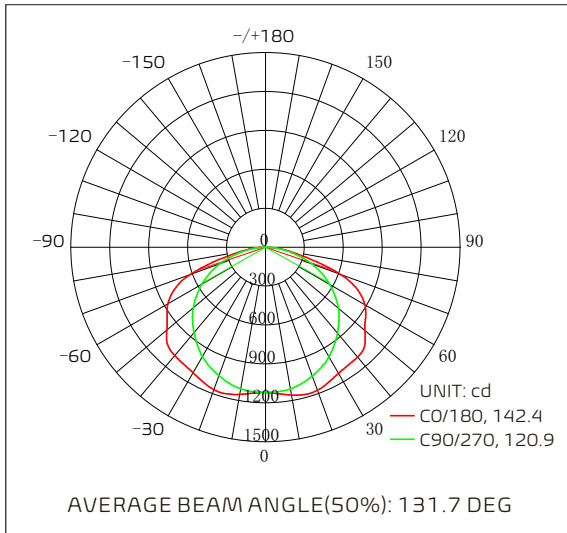

### Average Illuminance Curve

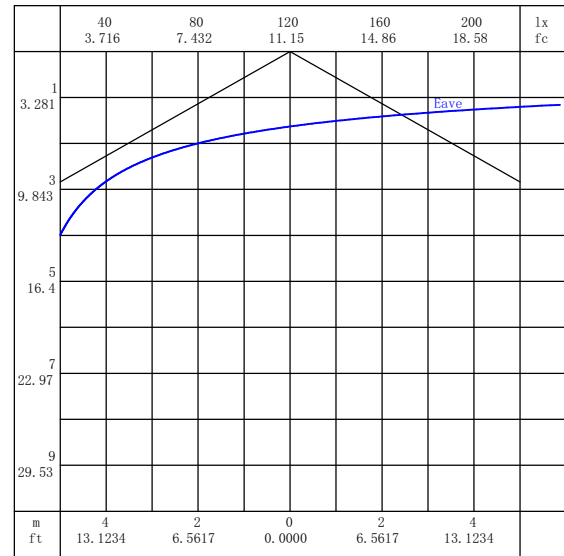

Note: The Curves indicate the illuminated area and the average illumination when the luminaire is at different distance.

### Zonal Flux Diagram

T	C0	C45	C90	C135	C180	C225	C270	C315
10	1157	1135	1109	1132	1152	1130	1108	1134
20	1173	1137	1056	1130	1168	1127	1053	1133
30	1124	1084	977.9	1075	1118	1073	974.1	1077
40	1105	998.6	863.3	985.1	1090	982.9	858.5	985.8
50	999.8	923.2	733.5	902.0	992.9	903.0	727.2	907.3
60	883.4	772.7	570.2	758.8	868.6	755.3	564.6	757.3
70	615.3	567.1	381.9	552.9	618.6	552.2	375.9	553.4
80	191.9	213.5	168.0	217.0	190.9	206.2	161.3	206.0
90	1.700	1.859	1.366	1.957	2.187	1.148	0.8020	1.977

DEG LUMINOUS INTENSITY:cd

### Zonal Lumen Summary

T	φ zone	φ total	%lum,jamp
0-10	107.6	107.6	2.58,2.92
10-20	320.4	428.0	10.2,11.6
20-30	507.4	935.2	22.4,25.4
30-40	643.9	1579	37.8,42.8
40-50	730.7	2310	55.3,62.6
50-60	733.8	3044	72.9,82.5
60-70	641.9	3686	88.2,99.9
70-80	384.2	4070	97.4,110
80-90	94.62	4164	99.7,113

UNIT: lm

### Coefficients Of Utilization

ppc	80%			70%			50%			30%			10%			0
	50%	30%	10%	50%	30%	10%	50%	30%	10%	50%	30%	10%	50%	30%	10%	
pw	20%			20%			20%			20%			20%			0
pfc	20%			20%			20%			20%			20%			
RCR	RCR:Room Cavity Ratio (CU)															
0.0	135	135	135	132	132	132	126	126	126	120	120	120	115	115	115	113
1.0	116	111	106	113	109	104	108	104	101	104	101	98	0	97	95	92
2.0	0	91	84	97	90	83	93	87	81	89	84	79	86	81	77	75
3.0	86	76	69	85	75	68	81	73	67	78	71	65	75	69	64	61
4.0	76	65	57	74	64	57	71	63	56	68	61	55	66	59	54	51
5.0	67	56	48	66	56	48	63	54	47	61	53	47	59	52	46	44
6.0	60	49	42	59	49	41	57	48	41	55	47	41	53	46	40	38
7.0	54	44	36	53	43	36	51	42	36	50	42	36	48	41	35	33
8.0	49	39	32	48	39	32	47	38	32	45	37	32	44	37	31	29
9.0	45	35	29	44	35	29	43	34	28	42	34	28	40	33	28	26
10.0	41	32	26	41	32	26	40	31	26	38	31	26	37	30	25	23



Date: \_\_\_\_\_  
 Project: \_\_\_\_\_  
 Price: \_\_\_\_\_

# Photometrics 50W:

## Luminous Intensity Distribution Diagram

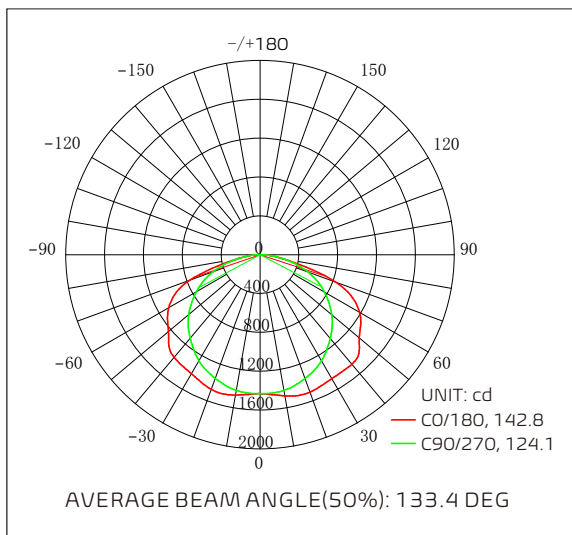

## Average Illuminance Curve

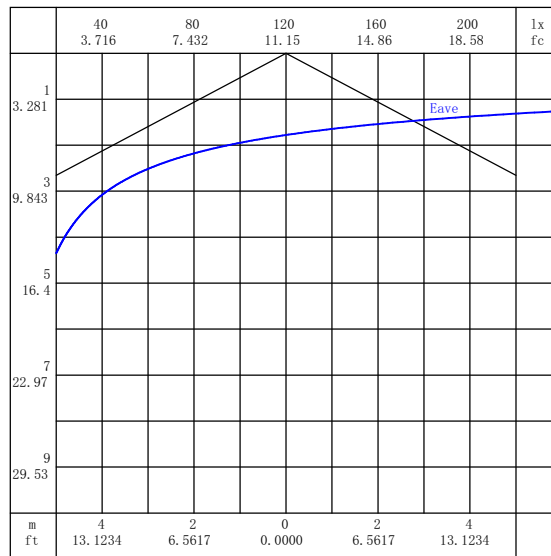

Note: The Curves indicate the illuminated area and the average illumination when the luminaire is at different distance.

## Zonal Flux Diagram

T	C0	C45	C90	C135	C180	C225	C270	C315
10	1476	1453	1419	1442	1467	1442	1418	1445
20	1506	1462	1356	1431	1475	1437	1355	1446
30	1475	1412	1264	1363	1415	1372	1261	1392
40	1472	1332	1124	1261	1380	1274	1120	1304
50	1334	1257	965.4	1162	1233	1179	960.5	1225
60	1183	1052	764.1	969.1	1087	977.6	756.6	1025
70	829.5	785.9	526.3	724.8	776.3	729.8	515.9	753.6
80	233.4	277.8	238.8	270.1	223.4	252.2	228.0	265.5
90	1.578	2.350	14.28	2.462	1.629	3.432	8.770	1.798
DEG	LUMINOUS INTENSITY:cd							

## Zonal Lumen Summary

T	φ zone	φ total	%lum,lamp
0-10	137.5	137.5	2.52,3
10-20	409.0	546.5	10,11.9
20-30	650.3	1197	21.9,26.1
30-40	834.8	2032	37.2,44.3
40-50	955.1	2987	54.7,65.2
50-60	965.2	3952	72.4,86.3
60-70	854.8	4807	88,105
70-80	518.8	5325	97.5,116
80-90	123.0	5448	99.8,119
	UNIT: lm		

## Coefficients Of Utilization

ppc	80%			70%			50%			30%			10%			0
	50%	30%	10%	50%	30%	10%	50%	30%	10%	50%	30%	10%	50%	30%	10%	0
pwf	20%			20%			20%			20%			20%			0
RCR	RCR:Room Cavity Ratio (CU)															
0.0	142	142	142	138	138	138	132	132	127	127	127	121	121	121	119	
1.0	122	116	111	119	114	109	114	110	106	109	106	103	105	102	99	
2.0	105	96	88	102	94	87	98	91	85	94	88	83	90	85	81	
3.0	91	80	72	89	79	71	85	77	70	82	74	68	78	72	67	
4.0	79	68	60	78	67	59	75	65	58	72	64	57	69	62	56	
5.0	70	59	50	69	58	50	66	57	49	64	55	49	61	54	48	
6.0	63	52	43	62	51	43	59	50	43	57	49	42	55	48	42	
7.0	57	46	38	56	45	38	54	44	37	52	43	37	50	43	37	
8.0	51	41	33	51	40	33	49	40	33	47	39	33	46	38	33	
9.0	47	37	30	46	36	30	45	36	29	43	35	29	42	35	29	
10.0	43	33	27	43	33	27	41	33	27	40	32	26	39	32	26	



Date: \_\_\_\_\_  
 Project: \_\_\_\_\_  
 Price: \_\_\_\_\_

## Microwave Sensor option

Line Voltage Daylight Harvest / Bi-Level

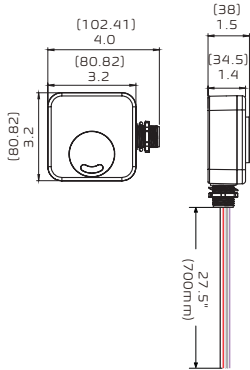

### Specifications

Operating Voltage	120/277VAC, 50Hz/60Hz
Switching Capacity	Resistive/Halogen-800W/1200@120/277V Fluorescent Ballast-660W/1200@120/277V Electronic Ballast(LED/CFL)-5A/5A@120/277V
Stand-by Power	≤0.5W
Detection Area	20%/50%/75%/100%
Hold Time	10s/1min/5min/10min/15min/20min/ 30min/60min
Daylight Threshold	10Lux/30Lux/50Lux
Stand-by Period	1min/30min/60min/+∞
Stand-by Dimming Level	0%/10%/30%/50%
Microwave Frequency	5.8GHz±5MHz
Microwave Power	< 0.2mW
Mounting Height	Max.6m
Detection Range	Max.8m
Control Line	VIOLET+,GRAY-,RED L' Out, WHITE N, BLACK L in
Operating Temperature	-40 °C ~+70 °C
IP Rating	IP20
Detection Angle	360°

### Detection Pattern

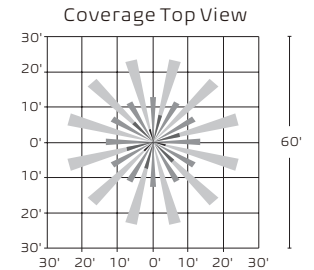

## Emergency Option

Up to 120 minutes in event of power failure

### Specifications

Output Power	8 Watts
Output Voltage	15-54V DC
Input Current	70 mA (Max)
Input Power	3.2 Watts (Max)
Input Voltage	100-277VAC, 50-60Hz
Emergency Operation	≥90 Minutes
Standby Power	< 0.4W
Operating Temp	0°C to 50°C
Battery	Lithium
Recharge	24 Hrs
Luminaire Load Power	100W (Max)
Dimensions	L10.64"×W1.98"×H1.32"
Certificate	UL , CEC
Output Class	UL LELV (Output protection self-resetting)

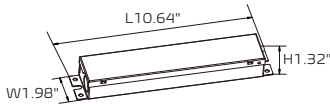
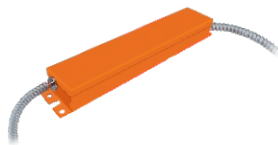

### T-Grid Hanger

It is designed to support LED emergency driver on the ceiling. Made of fire-rated galvanized sheet material, it is durable and safe, which won't conduct electricity. It has added stability to have the emergency driver be to quickly mount on the T-grid.

