

Date:	_____
Project:	_____
Price:	_____

Corning Linear Light

Description:

Our Corning Linear Light ensures an even illumination across any surface. Easily **LINKABLE** to create any length or shape. With an IP40 rating and multiple mounting options, this fixture is perfect for any office, retail, or lobbies.

Features:

- Voltage: 100~277VAC
- Housing Material: Aluminum + PC cover.
- IP Rating: IP40
- CRI >90
- Available Mounting Options: Suspended, Surface mounted, Recessed, or Wall mounted.

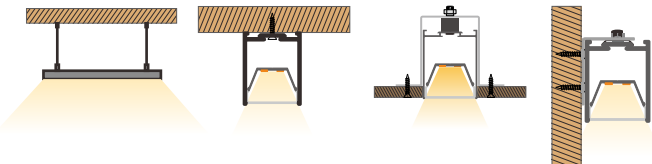
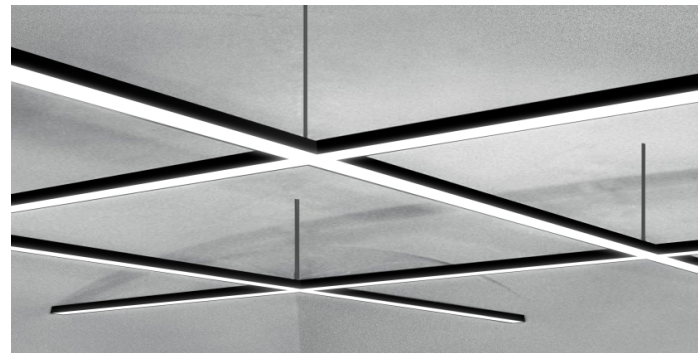
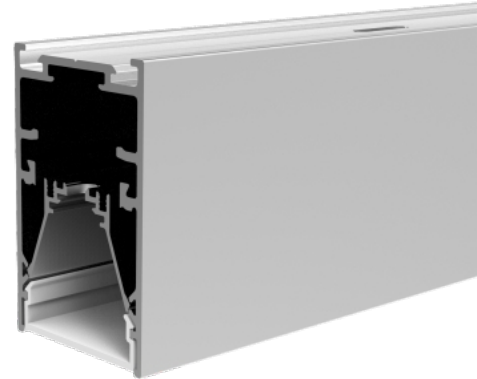

- Beam Angle: 90°
- UGR <19
- L70 Lifetime: >50,000 hours.
- Available Finish Options: Silver, White, Black
- 0-10V dimming option available.
- Lighting controls option available.
- 7 Year Warranty.

Dimensions:

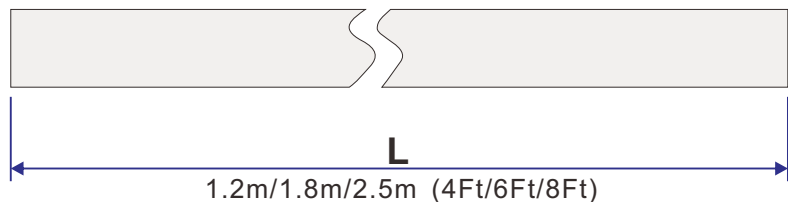
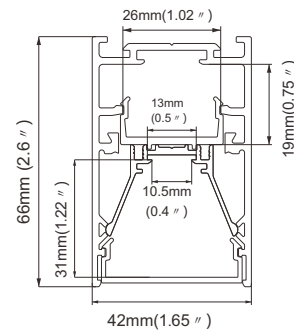

Date:	_____
Project:	_____
Price:	_____



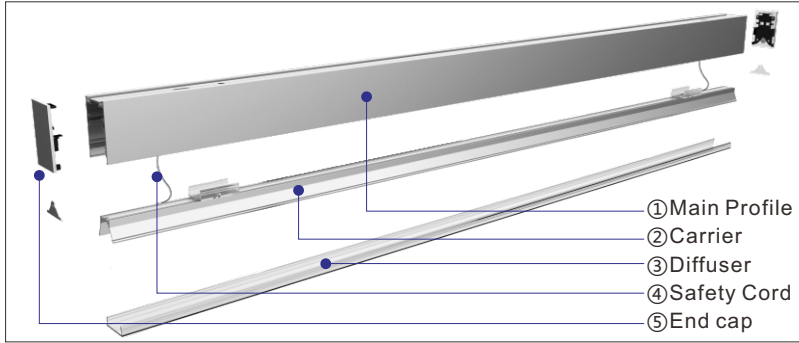







Components:







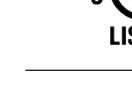

Linear Cover:



Optional Accessories:

Photo	Description	Model code
	Diffuser	DF
	Carrier clip	CC
	Pendant	PTB
	Pendant	PT
	Pendant	PF
	Pendant	NPF
	Ceiling	CBI
	Surface mounted	SM
	Wall mounted	WM
	Connection tool	CT
	Disassembly tool	DA

Connection Options:

Photo	Description	Model code	Size(mm)
	Connection	CN	100(L)*18(W)*2(H)
	Connection	LCN	200(L)*200(W)*66(H)
	Connection	L90	200(L)*200(W)*42(H)
	Connection	N90	200(L)*200(W)*42(H)
	Connection	T90	300(L)*200(W)*66(H)
	Connection	X90	300(L)*300(W)*66(H)



Date:	_____
Project:	_____
Price:	_____

Ordering Key:

SERIES NUMBER	SIZE	FINISH	LIGHTING CONTROLS	ADDITIONAL OPTIONS
ILLLCGBV	4FT - 4FT	S - SILVER	DM - 0-10V DIMMING	DF - DIFFUSER
	6FT - 6FT	WH - WHITE		CC - CARRIER CLIP
	8FT - 8FT	BL - BLACK		PTB - PENDANT MOUNT
				PT - PENDANT MOUNT
				PF - PENDANT MOUNT
				NPF - PENDANT MOUNT
				CBI - CEILING MOUNT
				SM - SURFACE MOUNT
				WM - WALL MOUNT
				CT - CONNECTION TOOL
		DA - DISASSEMBLY TOOL		

SAMPLE ITEM NUMBER: ILLLCGBV 4FT WH DM CC

Electrical Data:

- **Input Power:** Stays consistent over life.
- **Input Voltage:** 100-277 VAC
- **CRI:** >90
- **L70 Lifetime:** >50,000 hours.

Controls:

- This LED fixture is equipped with 0-10V dimming that works universally with any standard 0-10V control or dimmer.

Wiring Diagram:

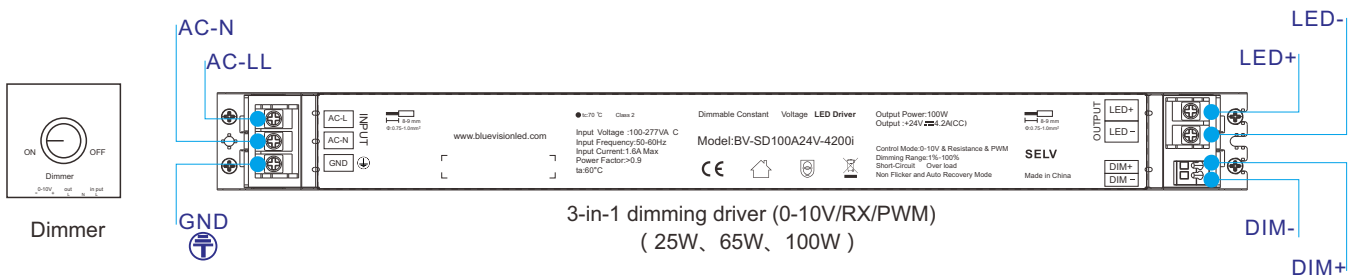



i-LUMINOSITY
LED LIGHTING FIXTURES

Date:	_____
Project:	_____
Price:	_____

Connection:

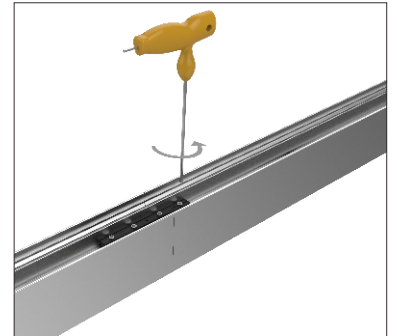
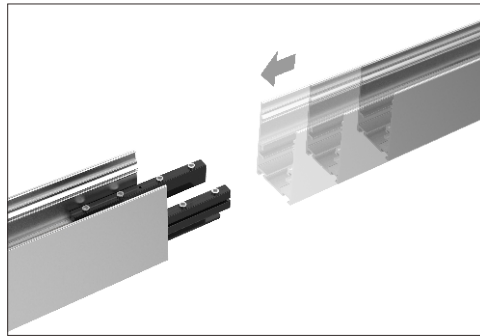
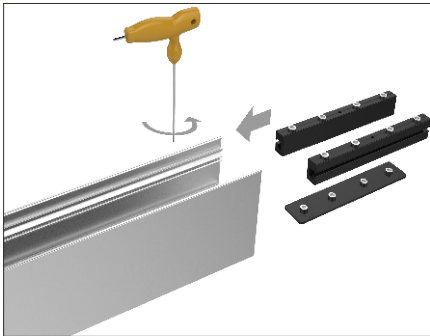
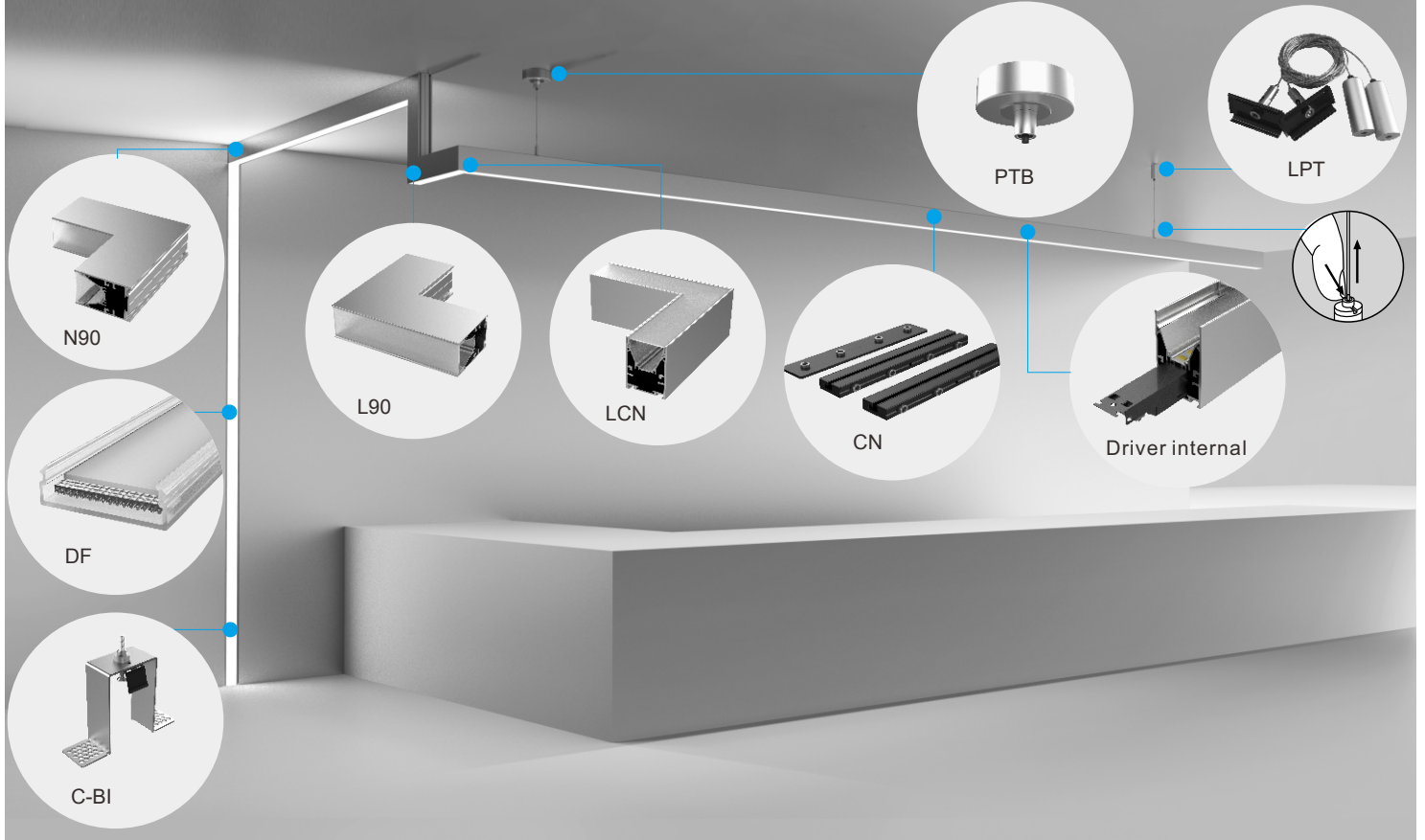

Connection Ordering Key:

ILLLCGBV	CONNECTION	ADDITIONAL OPTIONS
SERIES NUMBER		
ILLLCGBV	CN - CONNECTORS	
	LCN - L SHAPED CONNECTOR	
	L90 - L SHAPED CONNECTOR	
	N90 - N SHAPED CONNECTOR	
	T90 - T SHAPED CONNECTOR	
	X90 - X SHAPED CONNECTOR	