

Date:	_____
Project:	_____
Price:	_____

Corning Linear Light

Description:

Our Corning Linear Light ensures an even illumination across any surface. Easily **LINKABLE** to create any length or shape. With an IP40 rating and multiple mounting options, this fixture is perfect for any office, retail, or lobbies.

Features:

- Voltage: 100~277VAC
- Housing Material: Aluminum + PC cover.
- IP Rating: IP40
- CRI >90
- Available Mounting Options: Suspended, Surface mounted, Recessed, or Wall mounted.

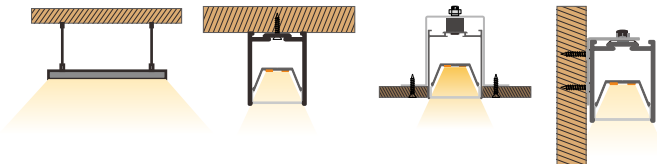
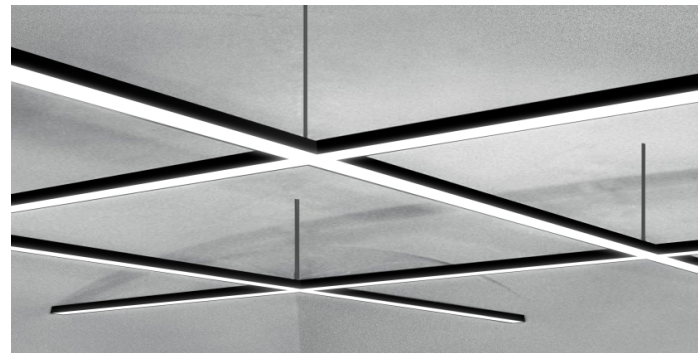
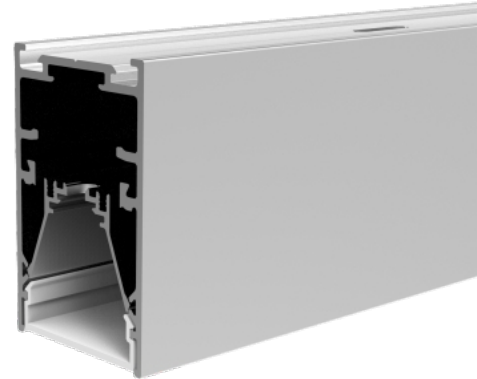

- Beam Angle: 90°
- UGR <19
- L70 Lifetime: >50,000 hours.
- Available Finish Options: Silver, White, Black
- 0-10V dimming option available.
- Lighting controls option available.
- 7 Year Warranty.

Dimensions:

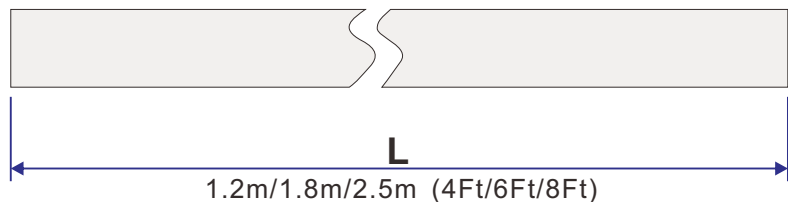
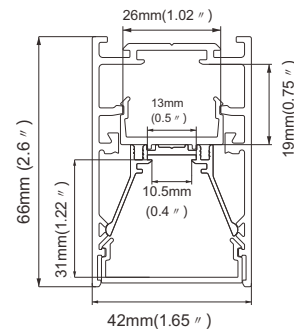

Date:	_____
Project:	_____
Price:	_____



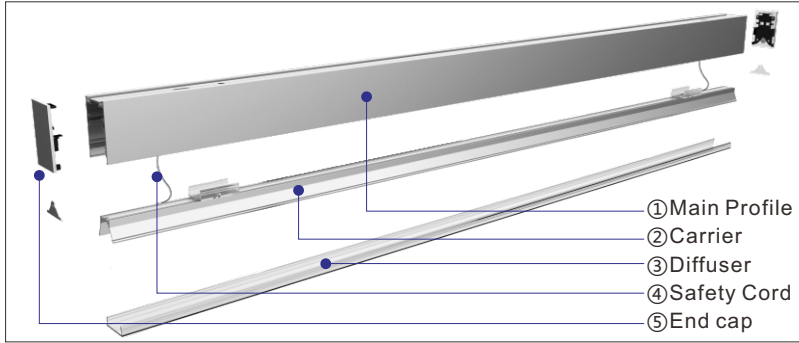







Components:







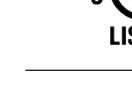

Linear Cover:



Optional Accessories:

Photo	Description	Model code
	Diffuser	DF
	Carrier clip	CC
	Pendant	PTB
	Pendant	PT
	Pendant	PF
	Pendant	NPF
	Ceiling	CBI
	Surface mounted	SM
	Wall mounted	WM
	Connection tool	CT
	Disassembly tool	DA

Connection Options:

Photo	Description	Model code	Size(mm)
	Connection	CN	100(L)*18(W)*2(H)
	Connection	LCN	200(L)*200(W)*66(H)
	Connection	L90	200(L)*200(W)*42(H)
	Connection	N90	200(L)*200(W)*42(H)
	Connection	T90	300(L)*200(W)*66(H)
	Connection	X90	300(L)*300(W)*66(H)





i-LUMINOSITY
LED LIGHTING FIXTURES

Date: _____
Project: _____
Price: _____

LED Strip:



- Power: 4.6 W/FT
- Lumens: 135 LM/W
- Voltage: 24Vdc
- Max Length: 16.4FT
- Beam Angle: 120°
- Rated life: 50,000 hours
- CRI>90
- Dimming: Triac, 0-10V or Smart.
- Available in 2700K, 3000K, 3500K, 4000K, 6000K

Test Report:

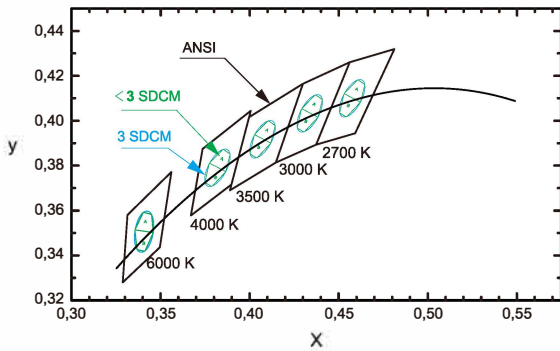

Impressive color consistency within 3 Step MacAdam in the center BIN on the Planck Locus over each individual LED, One Bin Only

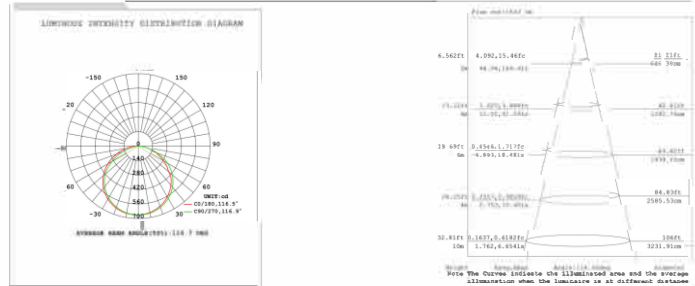
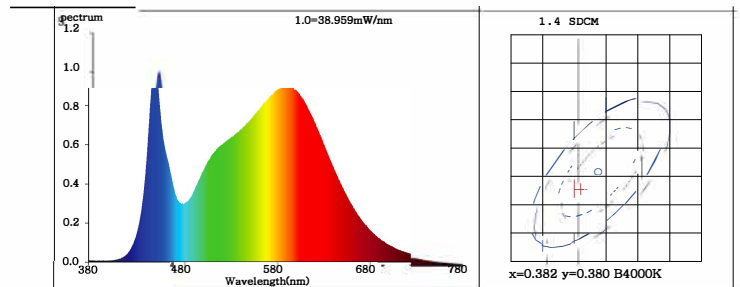

Compatible Additional Options:

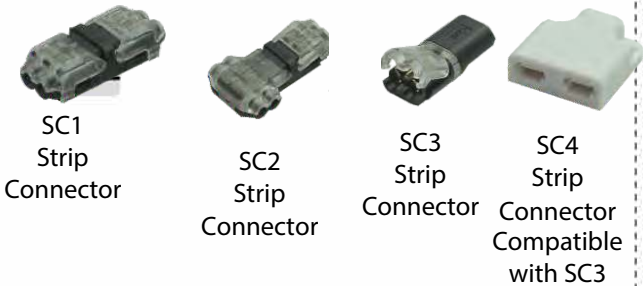

Dimensions:

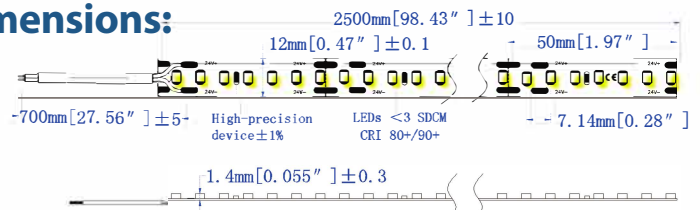

Date:	_____
Project:	_____
Price:	_____

Ordering Key:

SERIES NUMBER	SIZE	CCT	FINISH	LIGHTING CONTROLS	ADDITIONAL OPTIONS
ILLLCGBV	4FT - 4FT	27K - 2700K	S - SILVER	DM - 0-10V DIMMING	DF - DIFFUSER
	6FT - 6FT	3K - 3000K	WH - WHITE	TM - TRIAC DIMMING	CC - CARRIER CLIP
	8FT - 8FT	35K - 3500K	BL - BLACK	SM - SMART DIMMING	PTB - PENDANT MOUNT
		4K - 4000K			PT - PENDANT MOUNT
		6K - 6000K			PF - PENDANT MOUNT
					NPF - PENDANT MOUNT
					CBI - CEILING MOUNT
					SM - SURFACE MOUNT
					WM - WALL MOUNT
					CT - CONNECTION TOOL
				DA - DISASSEMBLY TOOL	

SAMPLE ITEM NUMBER: ILLLCGBV 4FT WH DM CC

Electrical Data:

- **Input Power:** Stays consistent over life.
- **Input Voltage:** 100-277 VAC
- **CRI:** >90
- **L70 Lifetime:** >50,000 hours.

Controls:

- This LED fixture is equipped with 0-10V dimming that works universally with any standard 0-10V control or dimmer.

Wiring Diagram:

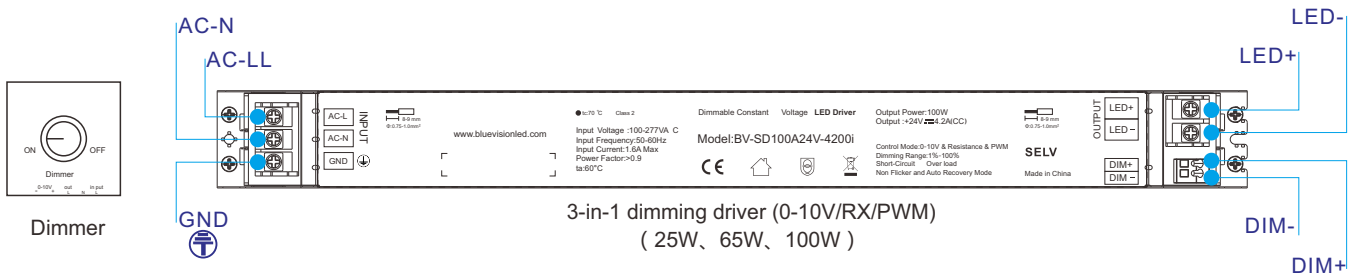



i-LUMINOSITY
LED LIGHTING FIXTURES

Date:	_____
Project:	_____
Price:	_____

Connection:

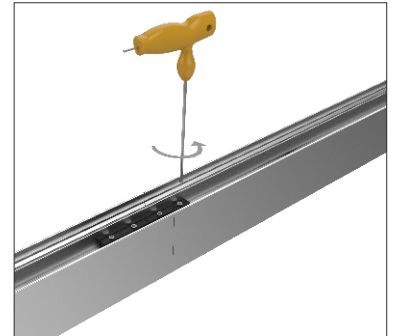
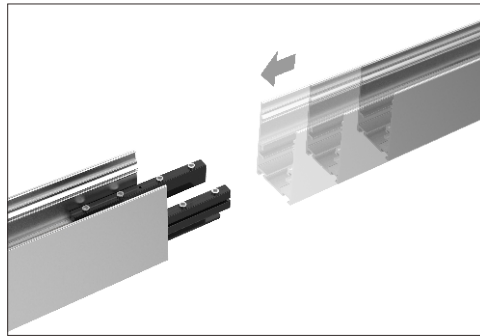
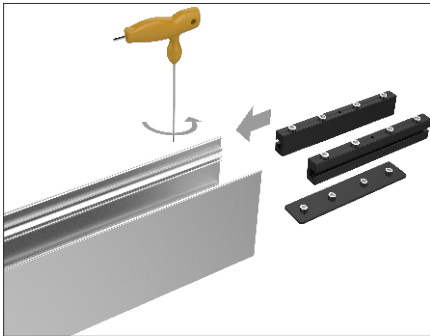
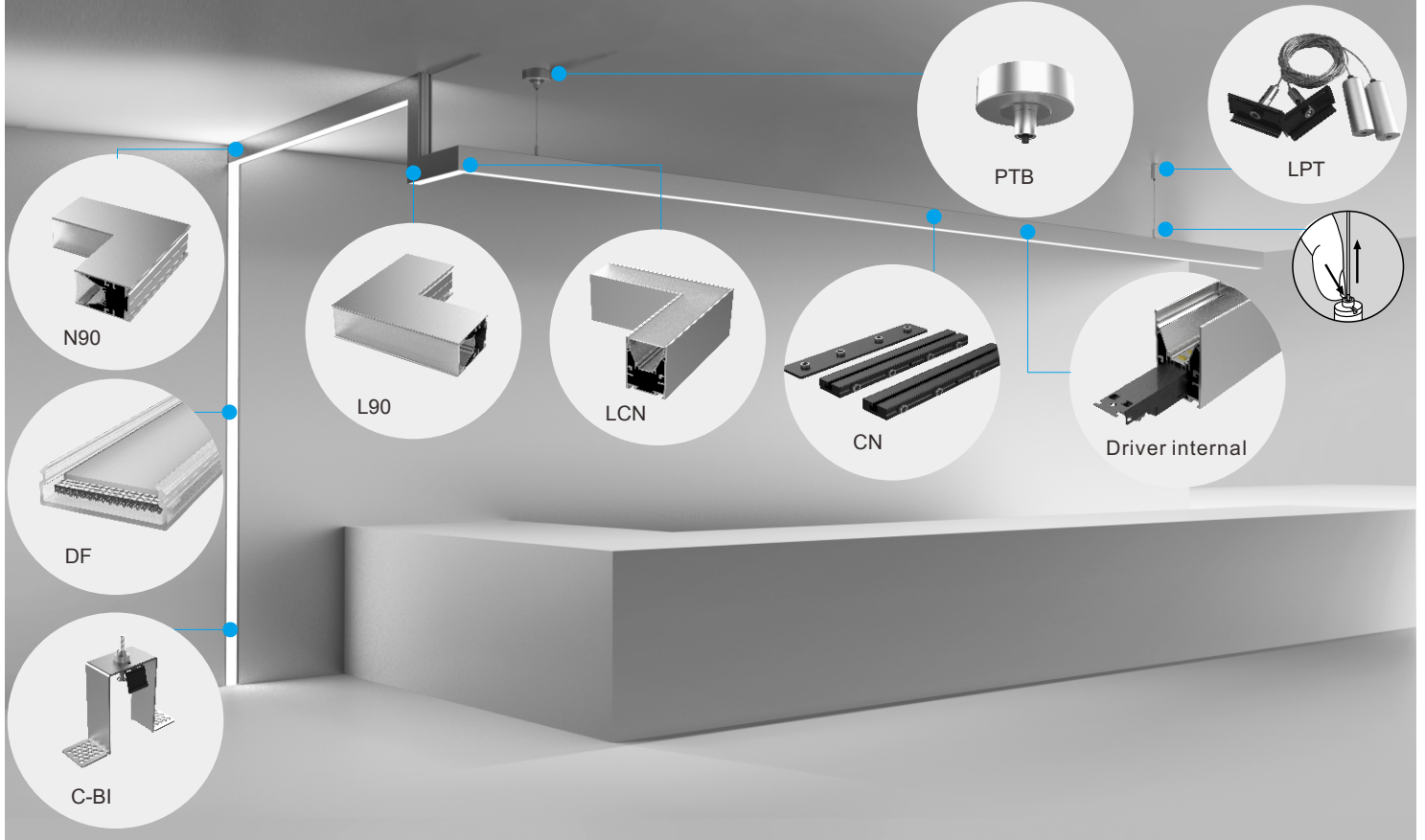

Connection Ordering Key:

ILLLCGBV	CONNECTION	ADDITIONAL OPTIONS
SERIES NUMBER	CN - CONNECTORS	
ILLLCGBV	LCN - L SHAPED CONNECTOR	
	L90 - L SHAPED CONNECTOR	
	N90 - N SHAPED CONNECTOR	
	T90 - T SHAPED CONNECTOR	
	X90 - X SHAPED CONNECTOR	