

Benson Recessed Linear Installation Instructions:

◆ Ceiling mounting accessories

① Expansion plug-RUS / 2 pcs

② Screw/ 2 pcs

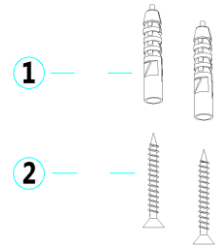

Installation step:

(1) Drill installation holes and wiring hole as per scale by "L"

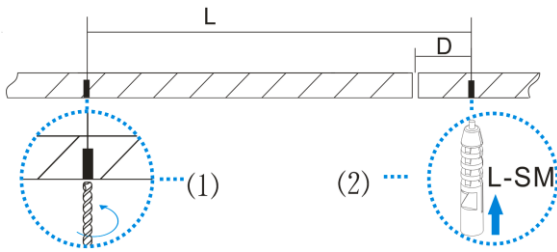

(2) Remove diffuser and carrier

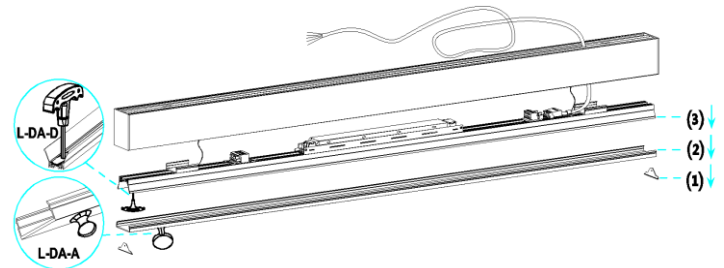

(3) Fix main profile onto ceiling

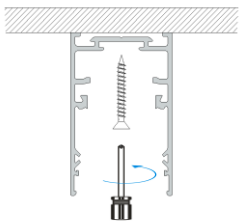

(4) Assemble carrier, diffuser and anti-lightleak clips

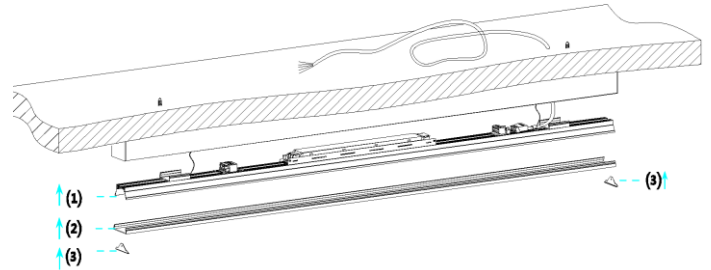

(5) Connect the lamp input line in outlet box according to the color mark corresponding to the city electricity and dimming signal line, strain relief device need to be used before cord entry the outlet box during installation

(6) Complete installation

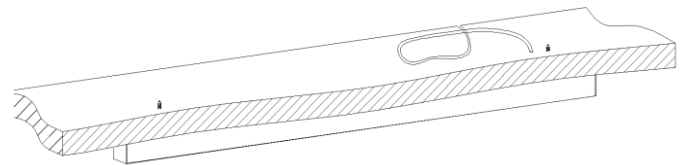
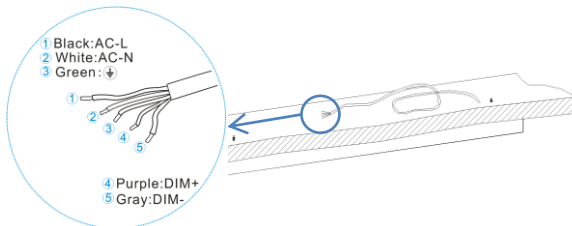

Explain: connect to ①、②、③ only if do not need to use dimming function, no need to connect ④、⑤

Ceiling mounting installation parameter

Size	1230mm (4.04Ft)	1839mm (6.03Ft)	L2449mm (8.03Ft)
φ6mm/hole scale by "L"	1025mm (3.36Ft) ±5mm	1435mm (4.71Ft) ±5mm	2045mm (6.71Ft) ±5mm
φ10mm/hole scale by "D"	50mm (0.16Ft) ±5mm		

Attention:

1. Please read instruction seriously before assembly & installation, lighting fixture must be assembled according to instruction by qualified & licensed electrician. Anything unclear please contact to manufacturer or local distributor.
2. The electric source must be cut off before assembly & installation or remove.
3. The lighting fixture is used only for indoor, the aim to avoid the risk of fire or electric shock, please do not use it for outdoor, vibrant, dusty and high humidity environment.
4. The aim to make sure not to shorten the life time of lighting fixture and keep safety, please do not modify, add or change any component.
5. Please cut off electric source immediately if any abnormality occur so that avoid any danger or malfunction, and lighting fixture must be checked and repaired by professional technician.

Benson Linear Pendant Installation Instructions:

◆ Pendant accessories

- ① Expansion plug-RUS / 2 pcs
- ② Self-tapping screw / 2 pcs
- ③ Davit / 2 pcs
- ④ Pendant wire/ 2 pcs
- ⑤ Hanging head / 1 pcs
- ⑥ Pedan clip / 2 pcs

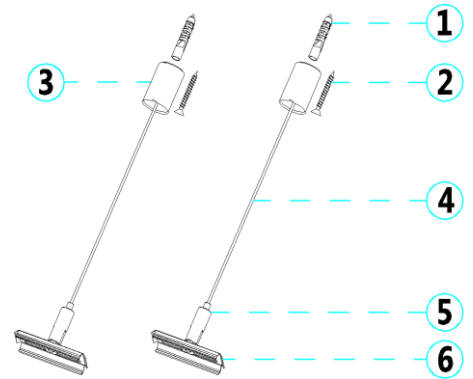

Installation step:

(1) Fix pendant wires on ceiling

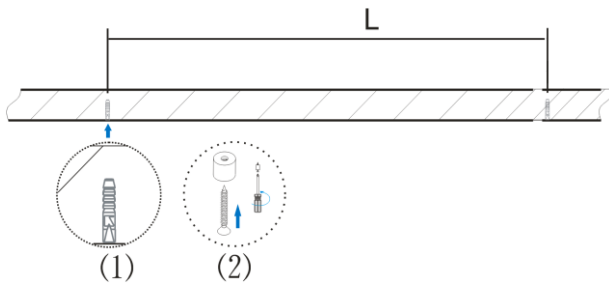

(2) Press pendant clips onto the back of linear light

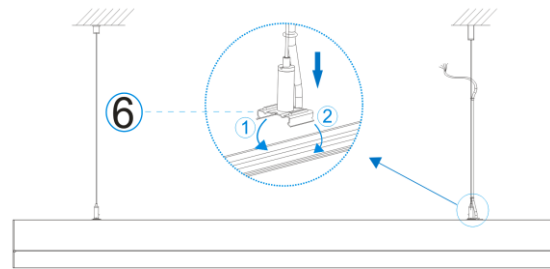

(3) Connect the lamp input line in outlet box according to the color mark corresponding to the city electricity and dimming signal line, strain relief device need to be used before cord entry the outlet box during installation.

(4) Complete installation

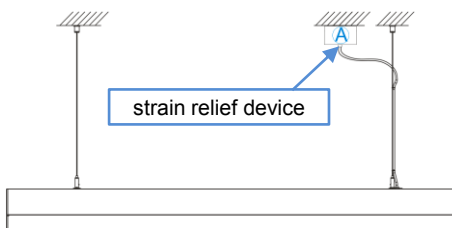
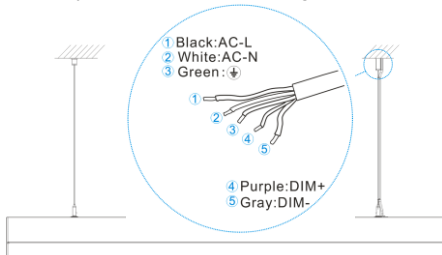

Explain: connect to ①、②、③ only if do not need to use dimming function, no need to connect ④、⑤

Note: (A) outlet box and strain relief device (prepare by user)

Pendant installation parameter

Size	1230mm (4.04Ft)	1839mm (6.03Ft)	L2449mm (8.03Ft)
φ6mm/hole scale by "L"	995mm(3.26Ft)±10mm	1340mm(4.40Ft)±10mm	1950mm(6.40Ft)±10mm

Attention:

1. Please read instruction seriously before assembly & installation, lighting fixture must be assembled according to instruction by qualified & licensed electrician. Anything unclear please contact to manufacturer or local distributor.
2. The electric source must be cut off before assembly & installation or remove.
3. The lighting fixture is used only for indoor, the aim to avoid the risk of fire or electric shock, please do not use it for outdoor, vibrant, dusty and high humidity environment.
4. The aim to make sure not to shorten the life time of lighting fixture and keep safety, please do not modify, add or change any component.
5. Please cut off electric source immediately if any abnormality occur so that avoid any danger or malfunction, and lighting fixture must be checked and repaired by professional technician.

Benson Linear Recessed Installation Instructions

◆ Recessed accessories

- ① screw for fixing bracket / 4 pcs
- ② screw for fixing lighting fixture / 2 pcs
- ③ M7 screw bolt / 2 pcs
- ④ M7 screw nut / 2 pcs
- ⑤ recessed bracket / 2 pcs
- ⑥ recessed spring plate / 2 pcs

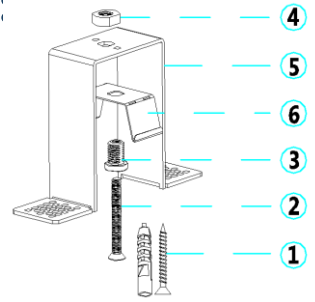

Installation step:

(1) Drill installation holes and wiring hole as per scale by "L"

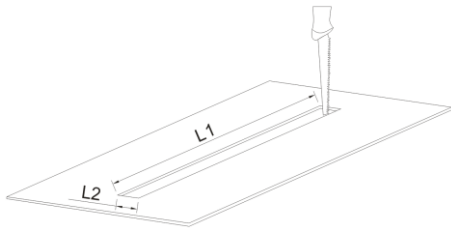

(2) Remove diffuser, carrier

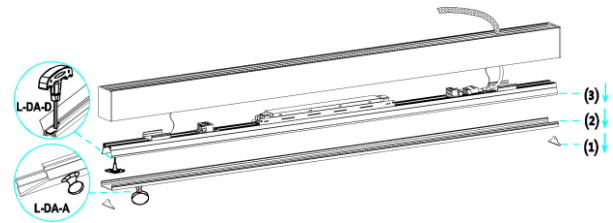

(3) Make input cord pass through the conduit, and Connect the input line according to the color mark corresponding to the city electricity and dimming signal line.

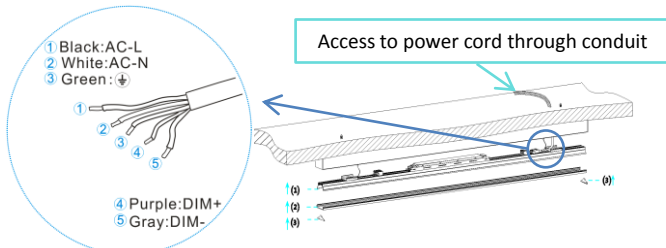

Explain: connect to ①、②、③ only if do not need to use dimming function, no need to connect ④、⑤

(4) Fix lighting fixture in the slot

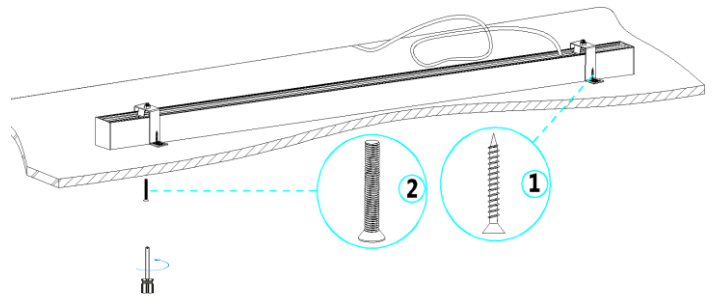

(5) Assemble carrier, diffuser and anti-lightleak clips

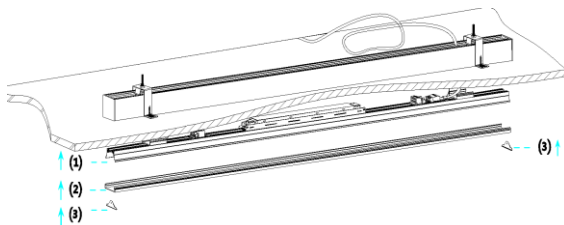

(6) Complete installation

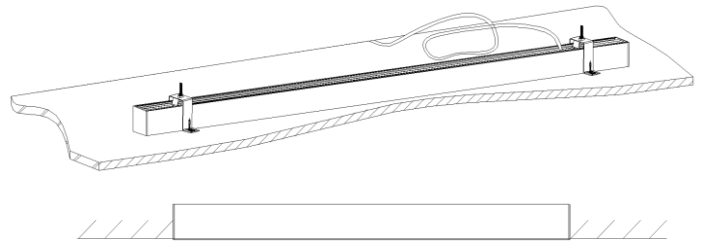

Recessed installation parameter

Size	1230mm (4.04Ft)	1839mm (6.03Ft)	L2449mm (8.03Ft)
L1 scale	1231mm (4.04Ft) ±1mm	1840mm (6.04Ft) ±1mm	2450mm (8.04Ft) ±1mm
L2 scale	L5570=56mm ; L7380=74mm ; L9086=91mm		

Attention:

1. Please read instruction seriously before assembly & installation, lighting fixture must be assembled according to instruction by qualified & licensed electrician. Anything unclear please contact to manufacturer or local distributor.
2. The electric source must be cut off before assembly & installation or remove.
3. The lighting fixture is used only for indoor, the aim to avoid the risk of fire or electric shock, please do not use it for outdoor, vibrant, dusty and high humidity environment.
4. The aim to make sure not to shorten the life time of lighting fixture and keep safety, please do not modify, add or change any component.
5. Please cut off electric source immediately if any abnormality occur so that avoid any danger or malfunction, and lighting fixture must be checked and repaired by professional technician.

Benson Linear Wall Mounting Instructions:

◆ Recessed accessories

- ① Expansion plug-RUS / 2 pcs
- ② Wall mounting clip / 2 pcs
- ③ Self-tapping screw / 2 pcs
- ④ M7 screw nut / 2 pcs
- ⑤ M4 screw bolt / 2 pcs
- ⑥ Pedan clip / 2 pcs
- ⑦ M7 screw bolt / 2 pcs

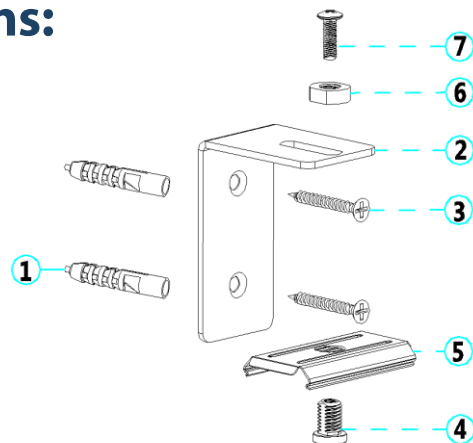

Installation step:

(1) Fixed wall mounting clips onto wall

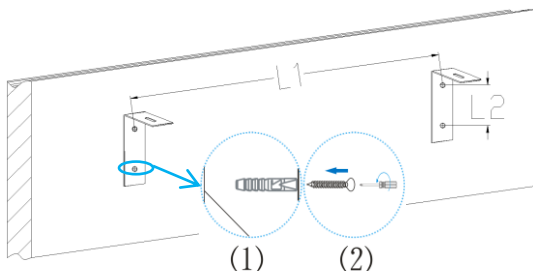

(2) Fixed linear light fixture on wall mounting bracket

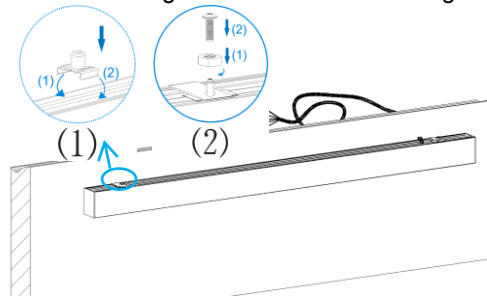

(3) Connect the lamp input line in outlet box according to the color mark corresponding to the city electricity and dimming signal line, strain relief device need to be used before cord entry the outlet box during installation.

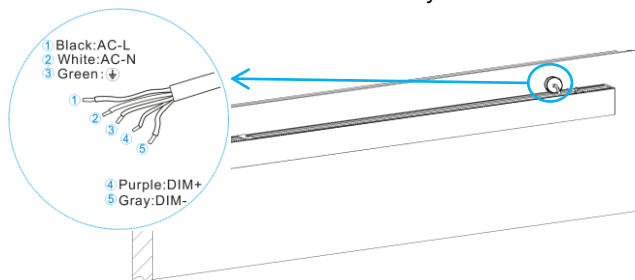

(4) Complete installation

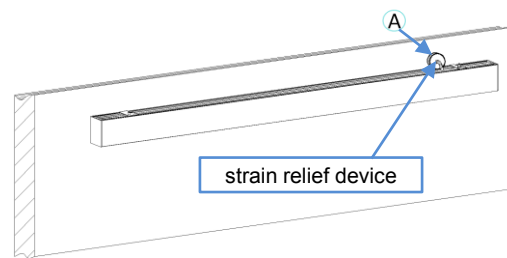

Explain: connect to ①、②、③ only if do not need to use dimming function, no need to connect ④、⑤

Note: A outlet box and strain relief device (prepare by user)

Wall mounting installation parameter

Size	1230mm (4.04Ft)	1839mm (6.03Ft)	L2449mm (8.03Ft)
φ6mm/hole scale by "L"	995mm(3.26Ft)±10mm	1340mm(4.40Ft)±10mm	1950mm(6.40Ft)±10mm
φ6mm/hole scale by "L"		30mm	

Attention:

1. Please read instruction seriously before assembly & installation, lighting fixture must be assembled according to instruction by qualified & licensed electrician. Anything unclear please contact to manufacturer or local distributor.
2. The electric source must be cut off before assembly & installation or remove.
3. The lighting fixture is used only for indoor, the aim to avoid the risk of fire or electric shock, please do not use it for outdoor, vibrant, dusty and high humidity environment.
4. The aim to make sure not to shorten the life time of lighting fixture and keep safety, please do not modify, add or change any component.
5. Please cut off electric source immediately if any abnormality occur so that avoid any danger or malfunction, and lighting fixture must be checked and repaired by professional technician.