



i-LUMINOSITY
LED LIGHTING FIXTURES

Date:	_____
Project:	_____
Price:	_____

BEDFORD UP & DOWN LINEAR LIGHT

Description:

Our Bedford Up & Down Linear Light ensures an even illumination across any surface. Easily **LINKABLE** to create any length or shape. With an IP40 rating and multiple mounting options, this fixture is perfect for any office, retail, or lobbies.

Features:

- Voltage: 100~277VAC
- Housing Material: Aluminum + PC cover.
- Wattage: 44W: 18W up/ 27W down
89W: 36W up/ 53W down
Indirect Only: 23W/4FT or 46W/8FT
- Input Power: 11W/FT or 1,100 LM/FT
- IP Rating: IP40
- CRI >90
- Available Color Options: 2700K, 3000K, 3500K, 4000K, 5000K or 6000K.
- Available Mounting Options: Wall mounted or Suspended.
- Customizable Lengths Available
- L70 Lifetime: >50,000 hours.
- Available Finish Options: Silver, White, Black
- 1-10V dimming option available.
- Lighting controls option available.
- 7 Year Warranty.

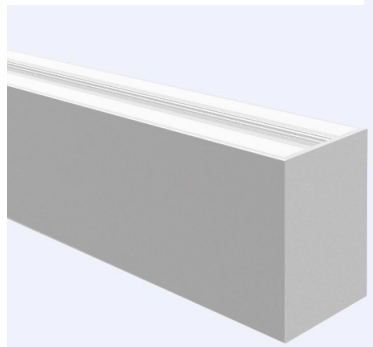
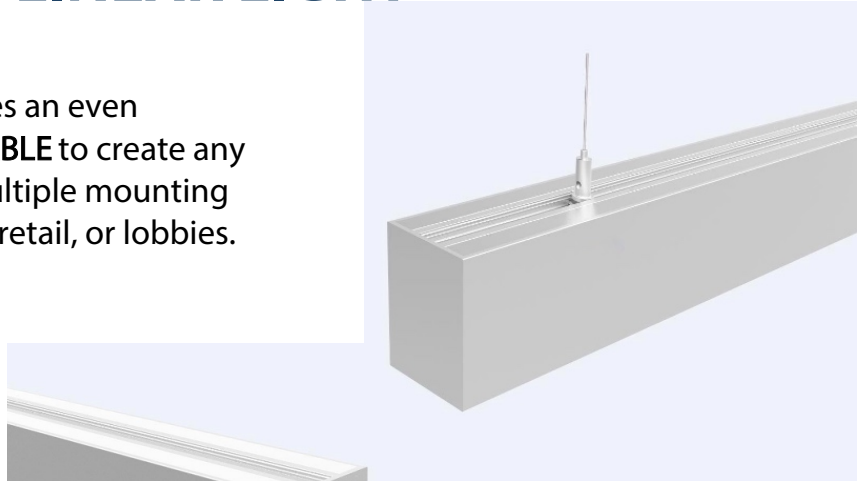

Dimensions:

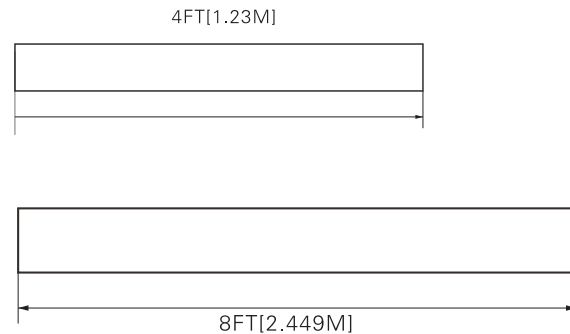
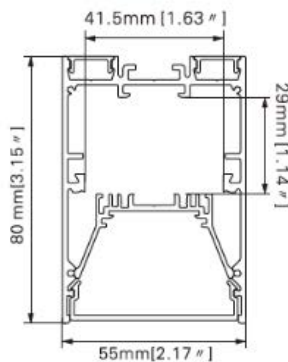

Date:	_____
Project:	_____
Price:	_____

Installation Accessories:



Pendant



L-PTB-S



L-PT-S



L-PTB-NPF-S



L-PTB-PF-S



Wall mounted



L5580D-WM

L-PTB-S: pendant wires with canopy

L-PT-S :pendant wires without canopy

L-PTB-NPF-S: pendant wire + canopy without cable hole

L-PTB-PF-S: pendant wire + canopy with cable hole

L5580D-WM: wall mounted clip

Disassembly Accessories:

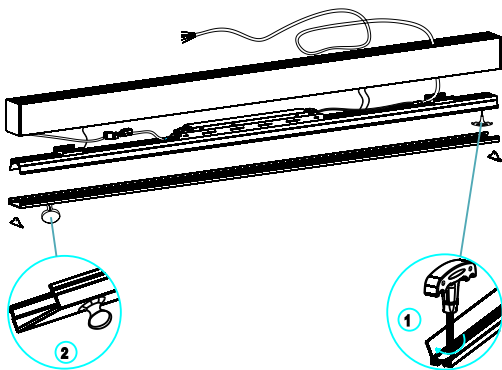

L-DA-D

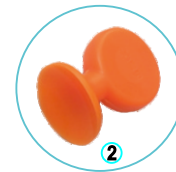

L-DA-A

L-DA-D: disassembly tool

L-DA-A: Rubber sucker



Date:	_____
Project:	_____
Price:	_____

Ordering Key:

SERIES NUMBER	WATTS/ SIZE/ LUMENS	CCT	FINISH	ADDITIONAL OPTIONS
ILLLBLBV	44W - 4FT/ 4,455	27 - 2700K	S - SILVER	DM - 1-10V DIMMING
	89W - 8FT/ 8,910	3 - 3000K	WH - WHITE	MS - MOTION SENSOR
	23W - 4FT/ 2,350*	35 - 3500K	BL - BLACK	EM - EMERGENCY BACKUP
	46W - 8FT/ 4,650*	4 - 4000K		
	X - SPECIFY CUSTOM LENGTH	5 - 5000K		
		6 - 6000K		

23W & 46W are only available as an indirect option

SAMPLE ITEM NUMBER: ILLLBLBV 44 4 S DM

Electrical Data:

- **Input Power:** Stays consistent over life.
- **Input Voltage:** 100-277 VAC
- **CRI:** >90
- **L70 Lifetime:** >50,000 hours.

Controls:

- This LED fixture is equipped with 1-10V dimming that works universally with any standard 1-10V control or dimmer.

Photometrics:

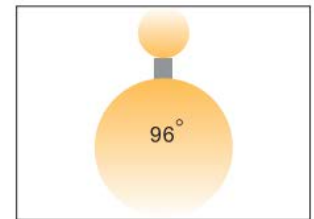
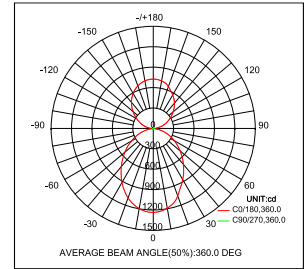
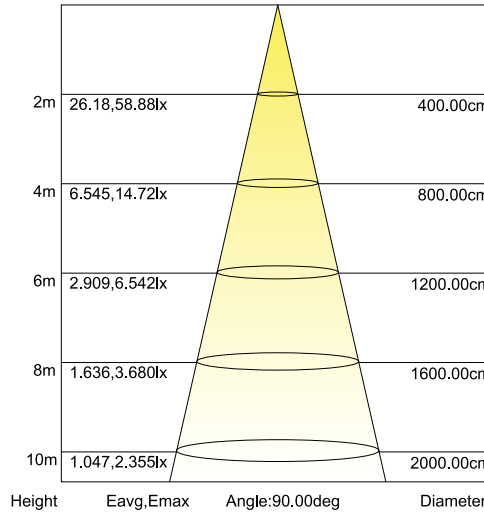

Optical System:

- A unique combination of reflective & refractive optical components achieves a uniform, comfortable look while eliminating pixelation & color fringing.
- Parts work in unison to optimize light distribution, balancing the high delivery of high illuminance levels on horizontal surfaces with an ideal amount of light on walls and vertical surfaces, increasing perception of spaciousness.

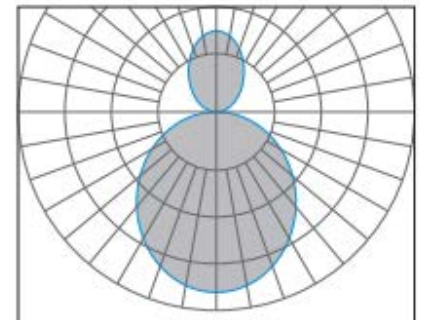



i-LUMINOSITY
LED LIGHTING FIXTURES

Date:	_____
Project:	_____
Price:	_____

Connectors:

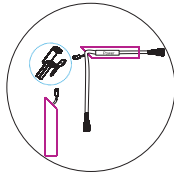

90L sets

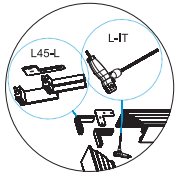

Mechanical connection

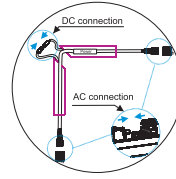

Electrical connection

Dimension: L609.6mm(2ft) * W609.6mm(2ft)

ITEM NUMBER: LL

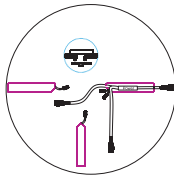
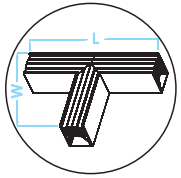

90T sets

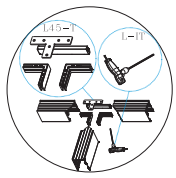

Mechanical connection

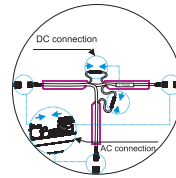

Electrical connection

Dimension: L1219.2mm(4ft) * W609.6mm(2ft)

ITEM NUMBER: TC

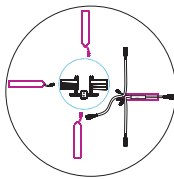
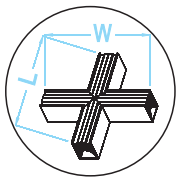

90X sets

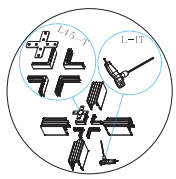

Mechanical connection

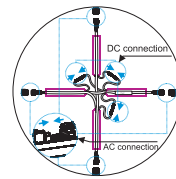

Electrical connection

Dimension: L1219.2mm(4ft) * W1219.2mm(4ft)

ITEM NUMBER: XC

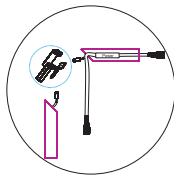
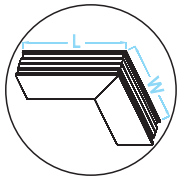

90N sets

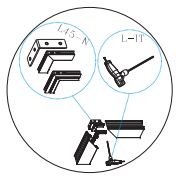

Mechanical connection

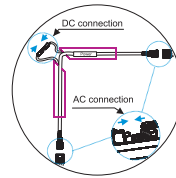

Electrical connection

Dimension: L609.6mm(2ft) * W609.6mm(2ft)

ITEM NUMBER: CC

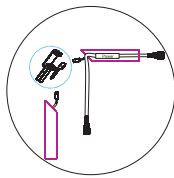
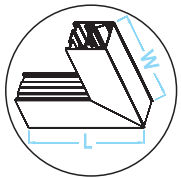

90W sets

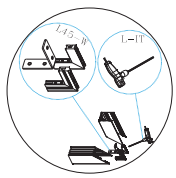

Mechanical connection

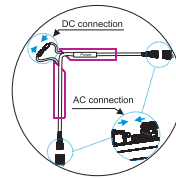

Electrical connection

Dimension: L609.6mm(2ft) * W609.6mm(2ft)

ITEM NUMBER: VC

Connection Ordering Key:

ILLLBBV

SERIES NUMBER	CONNECTION	ADDITIONAL OPTIONS
ILLLBBV	LL - L SHAPED CONNECTOR	
	TC - T SHAPED CONNECTOR	
	XC - X SHAPED CONNECTOR	
	CC - CORNER SHAPED CONNECTOR	
	VC - V SHAPED CONNECTOR	