



i-LUMINOSITY

LED LIGHTING FIXTURES

Date:	_____
Project:	_____
Price:	_____

Installation instruction For Recessed Fixture:

- ① Screw for fixing bracket / 4 pcs
- ② Screw for fixing lighting fixture / 2 pcs
- ③ Screw bolt / 2 pcs
- ④ Screw nut / 2 pcs
- ⑤ Recessed bracket / 2 pcs
- ⑥ Recessed spring plate / 2 pcs

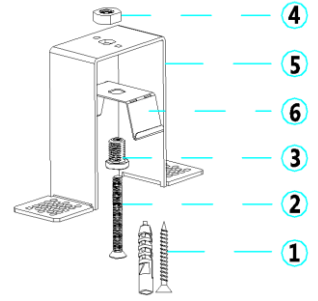

Installation step:

- (1) Drill installation holes and wiring hole as per scale by "L"
- (2) Remove diffuser, carrier

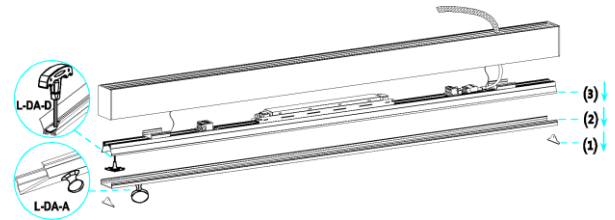
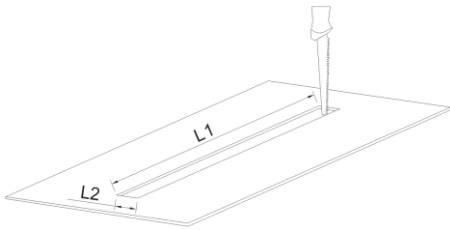

- (3) Make input cord pass through the conduit, and Connect the input line according to the color mark corresponding to the city electricity and dimming signal line.

- (4) Fix lighting fixture in the slot

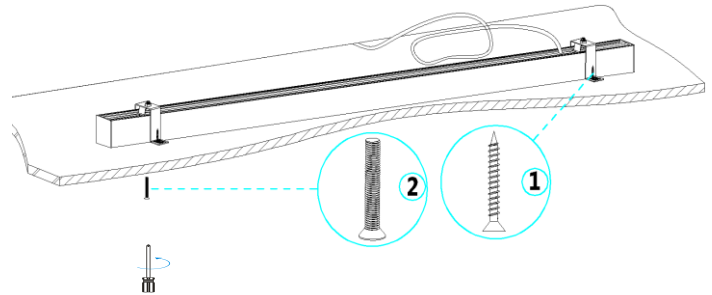
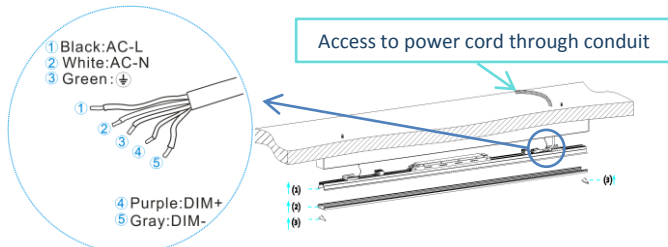

Explain: connect to ①、②、③ only if do not need to use dimming function, no need to connect ④、⑤

- (5) Assemble carrier, diffuser and anti-lightleak clips

- (6) Complete installation

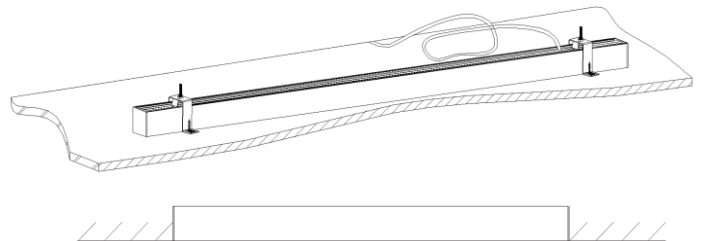
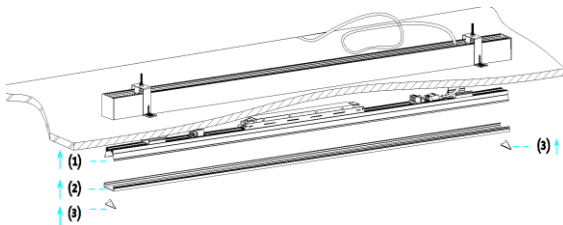

Attention:

1. Please read instruction seriously before assembly & installation, lighting fixture must be assembled according to instruction by qualified & licensed electrician. Anything unclear please contact to manufacturer or local distributor.
2. The electric source must be cut off before assembly & installation or remove.
3. The lighting fixture is used only for indoor, the aim to avoid the risk of fire or electric shock, please do not use it for outdoor, vibrant, dusty and high humidity environment.
4. The aim to make sure not to shorten the life time of lighting fixture and keep safety, please do not modify, add or change any component.
5. Please cut off electric source immediately if any abnormality occur so that avoid any danger or malfunction, and lighting fixture must be checked and repaired by professional technician.

