



**i-LUMINOSITY**  
LED LIGHTING FIXTURES

# Chelsea Linear Assembly Instructions:

## ◆ Components

- ① Main profile
- ② Light source holder (carrier) □
- ③ Diffuser
- ④ End cap
- ⑤ anti-lightleak clip
- ⑥ Straight connector
- ⑦ Screw driver

⑧ 5-core or 3-core SJT 18AWG input cable with male terminal block (8EDGKRB, DEGSON ELECTRONICS CO LTD) prepare by user

- ⑨ Connection cable

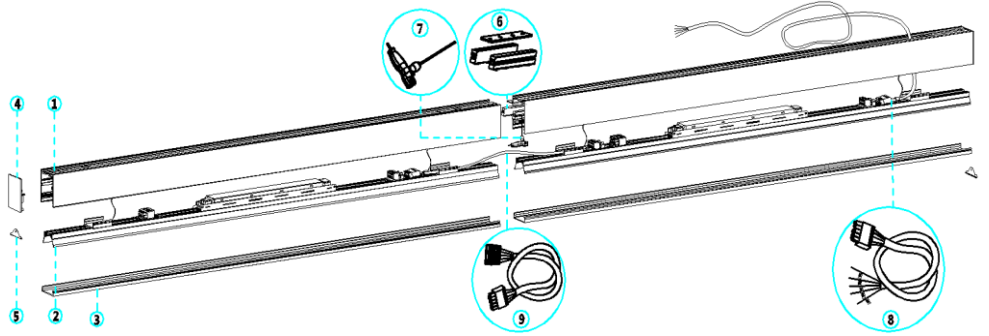

## Assembly

- (1) Remove diffuser, carrier and end cap in sequence of instructor (2) Insert straight connectors and then fixed connectors

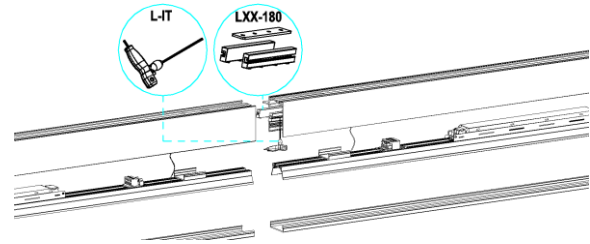
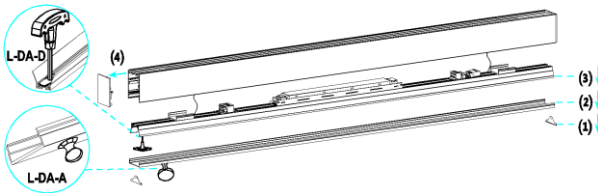

- (3) Connect AC input cable and connection cable

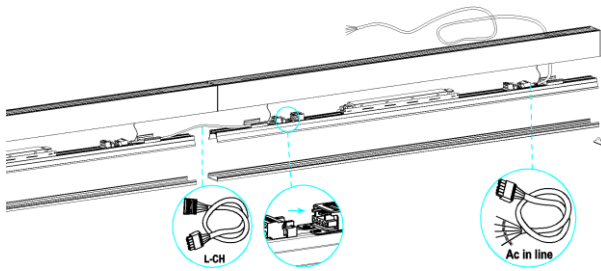

- (4) The power supply cord should be fixed by the strain relief device, and the signal line connect according to the color mark corresponding to the city electricity and dimming signal line

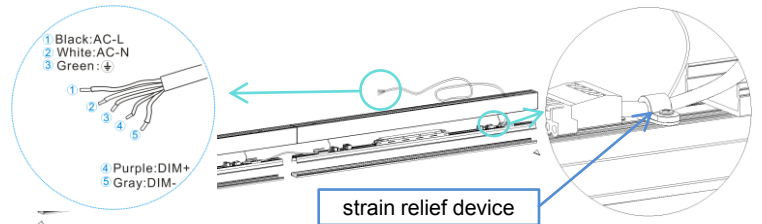

Explain: Please use 5-core or 3-core SJT 18AWG input cable , connect to ①、②、③ only if do not need to use dimming function, no need to connect ④、⑤

- (4) Assemble carrier, diffuser and anti-lightleak clips

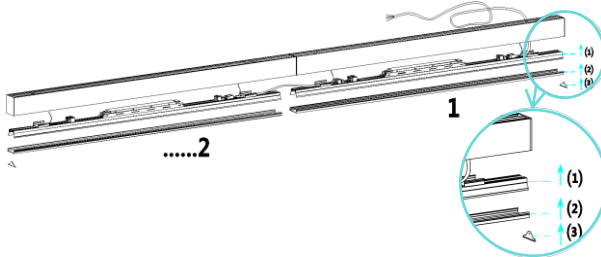

- (6) Complete assembly

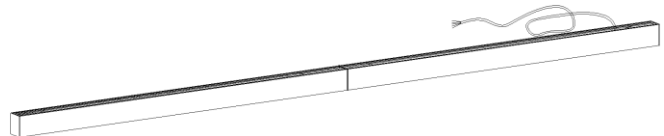

## Attention:

1. Please read instruction seriously before assembly & installation, lighting fixture must be assembled according to instruction by qualified & licensed electrician. Anything unclear please contact to manufacturer or local distributor.
2. The electric source must be cut off before assembly & installation or remove.
3. The lighting fixture is used only for indoor, the aim to avoid the risk of fire or electric shock, please do not use it for outdoor, vibrant, dusty and high humidity environment.
4. The aim to make sure not to shorten the life time of lighting fixture and keep safety, please do not modify, add or change any component.
5. Please cut off electric source immediately if any abnormality occur so that avoid any danger or malfunction, and lighting fixture must be checked and repaired by professional technician.

# Chelsea Linear Installation Instructions:

## ◆ Ceiling mounting accessories

① Expansion plug-RUS / 2 pcs

② Screw/ 2 pcs

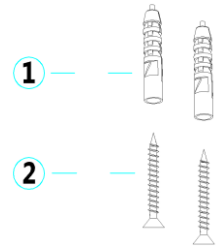

### Installation step:

(1) Drill installation holes and wiring hole as per scale by "L"

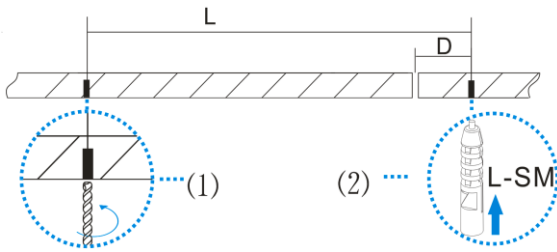

(2) Remove diffuser and carrier

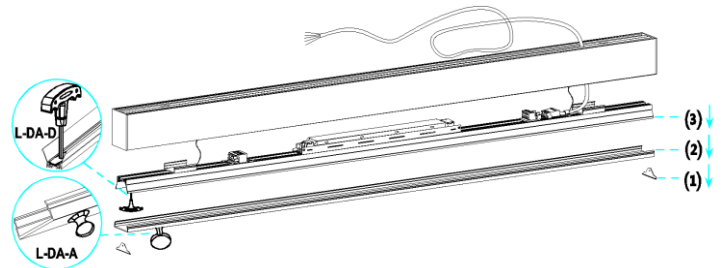

(3) Fix main profile onto ceiling

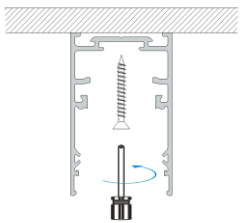

(4) Assemble carrier, diffuser and anti-lightleak clips

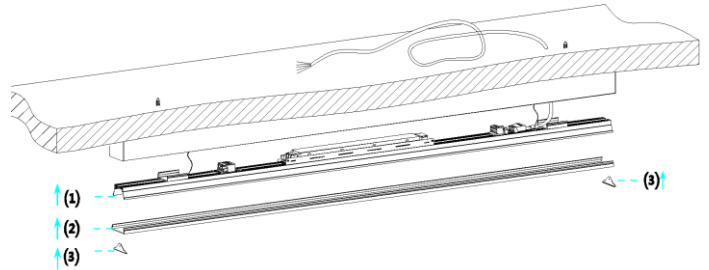

(5) Connect the lamp input line in outlet box according to the color mark corresponding to the city electricity and dimming signal line, strain relief device need to be used before cord entry the outlet box during installation

(6) Complete installation

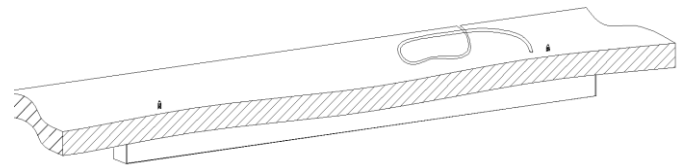
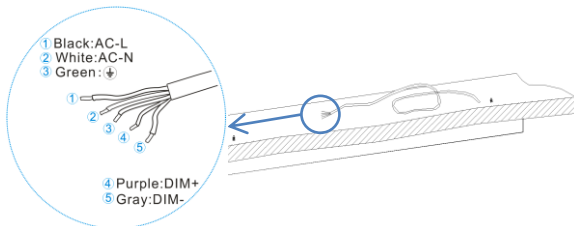

Explain: connect to ①、②、③ only if do not need to use dimming function, no need to connect ④、⑤

### Ceiling mounting installation parameter

Size	1230mm (4.04Ft)	1839mm (6.03Ft)	L2449mm (8.03Ft)
φ6mm/hole scale by "L"	1025mm (3.36Ft) ±5mm	1435mm (4.71Ft) ±5mm	2045mm (6.71Ft) ±5mm
φ10mm/hole scale by "D"	50mm (0.16Ft) ±5mm		

### Attention:

- Please read instruction seriously before assembly & installation, lighting fixture must be assembled according to instruction by qualified & licensed electrician. Anything unclear please contact to manufacturer or local distributor.
- The electric source must be cut off before assembly & installation or remove.
- The lighting fixture is used only for indoor, the aim to avoid the risk of fire or electric shock, please do not use it for outdoor, vibrant, dusty and high humidity environment.
- The aim to make sure not to shorten the life time of lighting fixture and keep safety, please do not modify, add or change any component.
- Please cut off electric source immediately if any abnormality occur so that avoid any danger or malfunction, and lighting fixture must be checked and repaired by professional technician.



**i-LUMINOSITY**  
LED LIGHTING FIXTURES

# Chelsea Linear Pendant Installation Instructions:

## ◆ Pendant accessories

- ① Expansion plug-RUS / 2 pcs
- ② Self-tapping screw / 2 pcs
- ③ Davit / 2 pcs
- ④ Pendant wire/ 2 pcs
- ⑤ Hanging head / 1 pcs
- ⑥ Pedan clip / 2 pcs

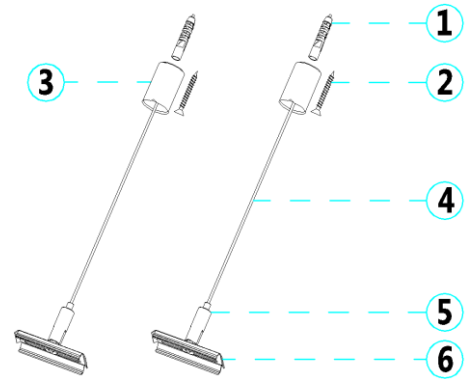

## Installation step:

(1) Fix pendant wires on ceiling

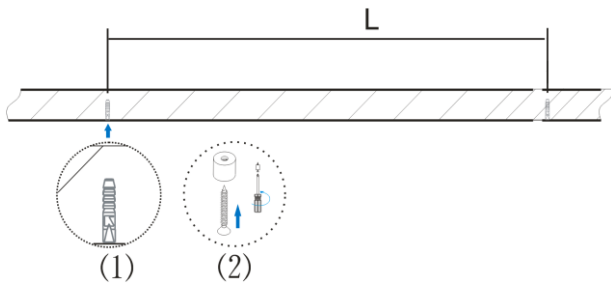

(2) Press pendant clips onto the back of linear light

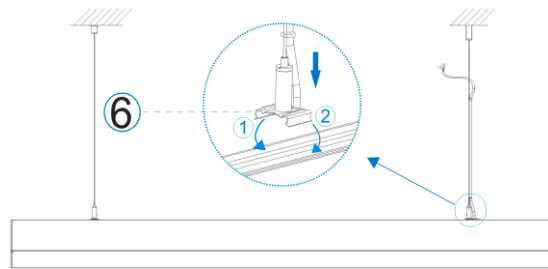

(3) Connect the lamp input line in outlet box according to the color mark corresponding to the city electricity and dimming signal line, strain relief device need to be used before cord entry the outlet box during installation.

(4) Complete installation

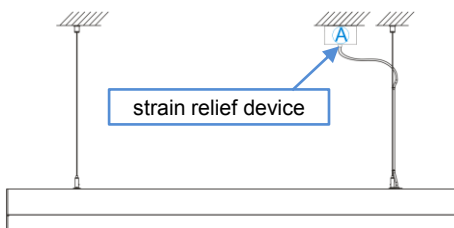
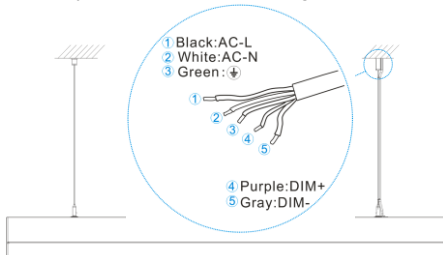

Explain: connect to ①、②、③ only if do not need to use dimming function, no need to connect ④、⑤

Note: A outlet box and strain relief device (prepare by user)

## Pendant installation parameter

Size	1230mm (4.04Ft)	1839mm (6.03Ft)	L2449mm (8.03Ft)
φ6mm/hole scale by "L"	995mm(3.26Ft)±10mm	1340mm(4.40Ft)±10mm	1950mm(6.40Ft)±10mm

## Attention:

- Please read instruction seriously before assembly & installation, lighting fixture must be assembled according to instruction by qualified & licensed electrician. Anything unclear please contact to manufacturer or local distributor.
- The electric source must be cut off before assembly & installation or remove.
- The lighting fixture is used only for indoor, the aim to avoid the risk of fire or electric shock, please do not use it for outdoor, vibrant, dusty and high humidity environment.
- The aim to make sure not to shorten the life time of lighting fixture and keep safety, please do not modify, add or change any component.
- Please cut off electric source immediately if any abnormality occur so that avoid any danger or malfunction, and lighting fixture must be checked and repaired by professional technician.

# Chelsea Linear Recessed Installation Instructions

## ◆ Recessed accessories

- ① screw for fixing bracket / 4 pcs      ④ M7 screw nut / 2 pcs
- ② screw for fixing lighting fixture / 2 pcs      ⑤ recessed bracket / 2 pcs
- ③ M7 screw bolt / 2 pcs      ⑥ recessed spring plate / 2 pcs

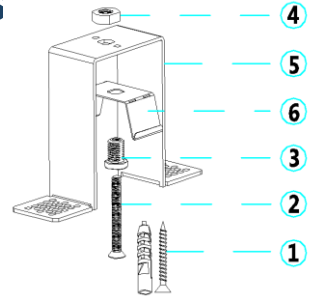

## Installation step:

- (1) Drill installation holes and wiring hole as per scale by "L"      (2) Remove diffuser, carrier

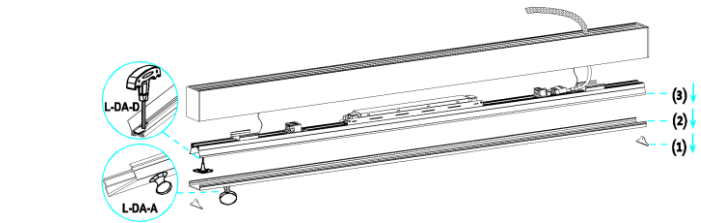
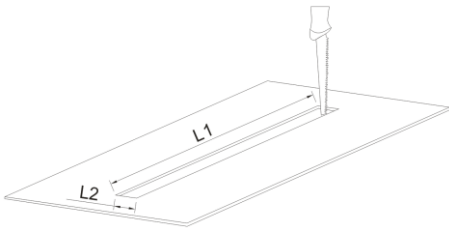

- (3) Make input cord pass through the conduit, and Connect the input line according to the color mark corresponding to the city electricity and dimming signal line.

- (4) Fix lighting fixture in the slot

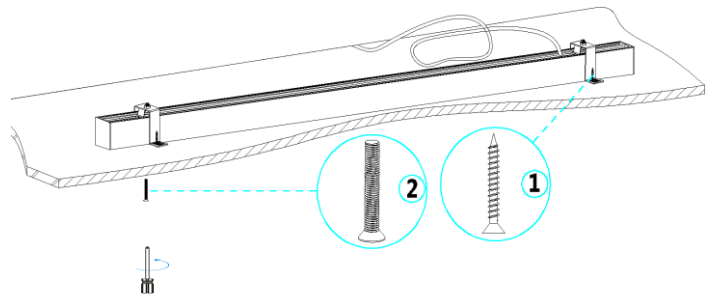
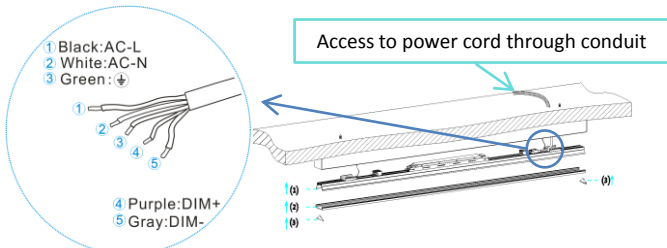

Explain: connect to ①、②、③ only if do not need to use dimming function, no need to connect ④、⑤

- (5) Assemble carrier, diffuser and anti-lightleak clips

- (6) Complete installation

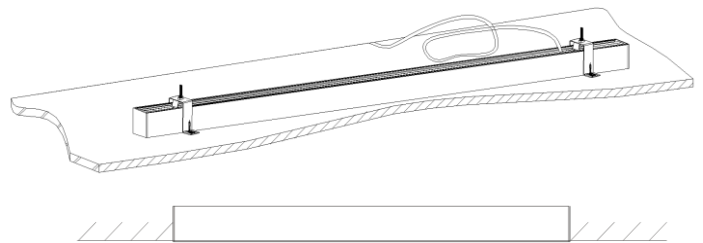
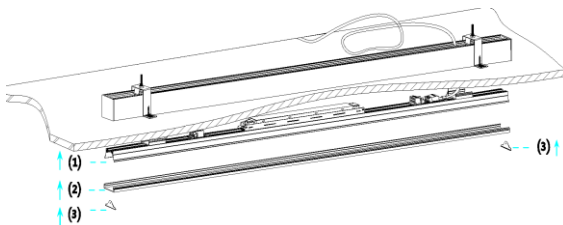

## Recessed installation parameter

Size	1230mm (4.04Ft)	1839mm (6.03Ft)	L2449mm (8.03Ft)
L1 scale	1231mm (4.04Ft) ±1mm	1840mm (6.04Ft) ±1mm	2450mm (8.04Ft) ±1mm
L2 scale	L5570=56mm ; L7380=74mm ; L9086=91mm		

## Attention:

1. Please read instruction seriously before assembly & installation, lighting fixture must be assembled according to instruction by qualified & licensed electrician. Anything unclear please contact to manufacturer or local distributor.
2. The electric source must be cut off before assembly & installation or remove.
3. The lighting fixture is used only for indoor, the aim to avoid the risk of fire or electric shock, please do not use it for outdoor, vibrant, dusty and high humidity environment.
4. The aim to make sure not to shorten the life time of lighting fixture and keep safety, please do not modify, add or change any component.
5. Please cut off electric source immediately if any abnormality occur so that avoid any danger or malfunction, and lighting fixture must be checked and repaired by professional technician.

# Chelsea Linear Wall Mounting Instructions:

## ◆ Recessed accessories

- ① Expansion plug-RUS / 2 pcs
- ② Wall mounting clip / 2 pcs
- ③ Self-tapping screw / 2 pcs
- ④ M7 screw nut / 2 pcs
- ⑤ M4 screw bolt / 2 pcs
- ⑥ Pedan clip / 2 pcs
- ⑦ M7 screw bolt / 2 pcs

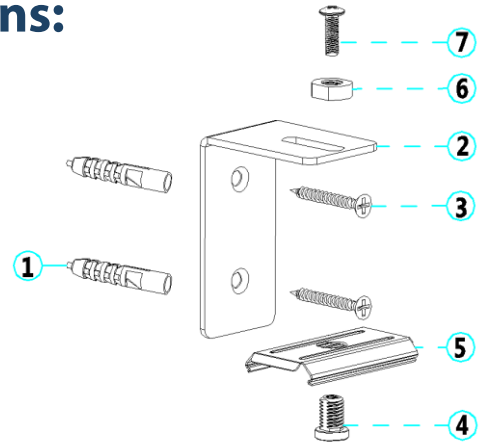

## Installation step:

(1) Fixed wall mounting clips onto wall

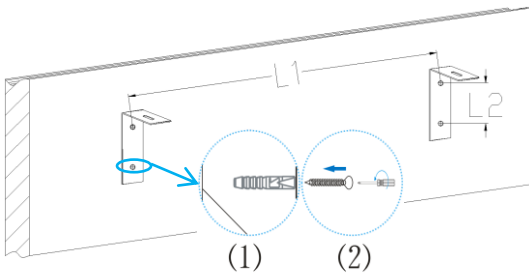

(2) Fixed linear light fixture on wall mounting bracket

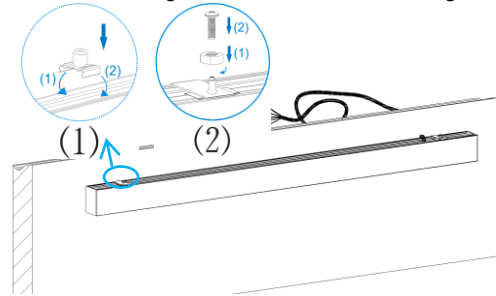

(3) Connect the lamp input line in outlet box according to the color mark corresponding to the city electricity and dimming signal line, strain relief device need to be used before cord entry the outlet box during installation.

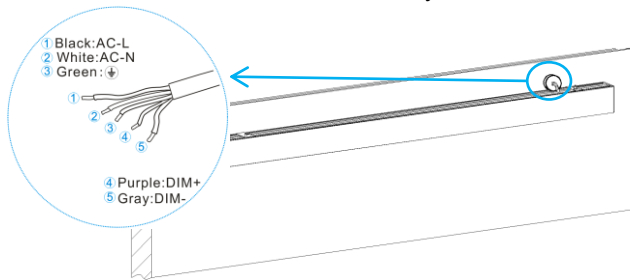

(4) Complete installation

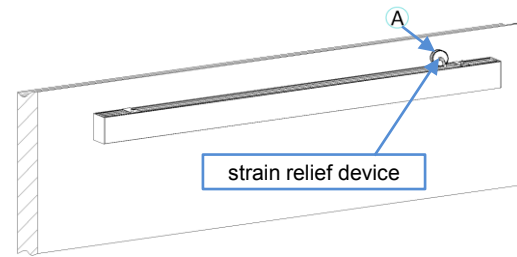

Explain: connect to ①、②、③ only if do not need to use dimming function, no need to connect ④、⑤

Note: A outlet box and strain relief device (prepare by user)

## Wall mounting installation parameter

Size	1230mm (4.04Ft)	1839mm (6.03Ft)	L2449mm (8.03Ft)
φ6mm/hole scale by "L"	995mm(3.26Ft)±10mm	1340mm(4.40Ft)±10mm	1950mm(6.40Ft)±10mm
φ6mm/hole scale by "L"		30mm	

## Attention:

1. Please read instruction seriously before assembly & installation, lighting fixture must be assembled according to instruction by qualified & licensed electrician. Anything unclear please contact to manufacturer or local distributor.
2. The electric source must be cut off before assembly & installation or remove.
3. The lighting fixture is used only for indoor, the aim to avoid the risk of fire or electric shock, please do not use it for outdoor, vibrant, dusty and high humidity environment.
4. The aim to make sure not to shorten the life time of lighting fixture and keep safety, please do not modify, add or change any component.
5. Please cut off electric source immediately if any abnormality occur so that avoid any danger or malfunction, and lighting fixture must be checked and repaired by professional technician.