



i-LUMINOSITY
LED LIGHTING FIXTURES

Date:	_____
Project:	_____
Price:	_____

STRAIGHT STEEL POLE

Description:

Our Straight Steel Pole created from the highest grade structural steel cast iron. With a choice between 2 shaft strengths, minimum yield of 46,000PSI or 55,000 PSI. With a polyester power coat finish to ensure maximum paint adhesion. Wall thickness available in gauge 11 (.120") or gauge 7(.180)

Features:

- Textured Architectural Bronze Powdercoat Finish, Baked to Ensure Maximum Paint Adhesion, Hardness and Durability.
- Polyester power coat finish
- Polycarbonate spring loaded cover
- Easily secured base cover
- Anchor bolt sets included

Choice of two shaft strengths

1. Minimum yield of 46,000 PSI
 2. Minimum yield of 55,000 PSI
- 7 Year Warranty.
 - Wall thickness available in gauge 11 (.120") or gauge 7(.180)



10-30 Feet

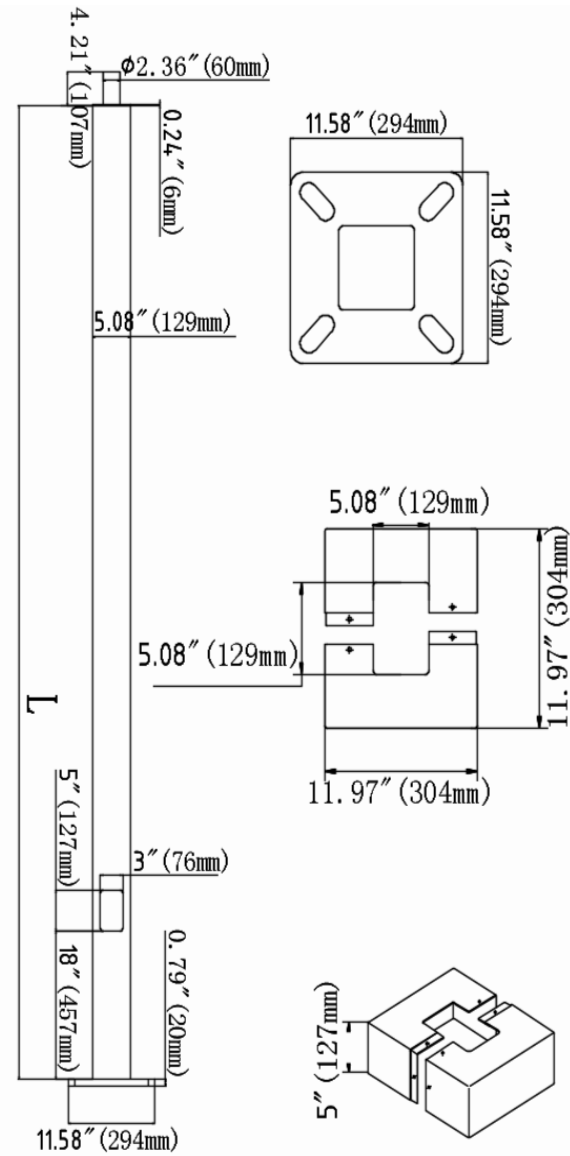

Date:	_____
Project:	_____
Price:	_____

Ordering Key:

SERIES NUMBER	SIZE/ GAGE	FINISH	BASE PLATE SIZE
ILSBPOWD	10'/11	B - BLACK BR - BRONZE WH - WHITE	10.5 X 10.5 X 3/4IN
	15'/ 11		
	16' /11		
	20' /11		
	20' /7		
	25'/11		
	25' /7		
	30'/ 11		

SAMPLE ITEM NUMBER: ILSBPOWD 16 B

Mt. height	Wall thickness	Shaft size	Base size	Bolt circle	Bolt projection	Bolt size	Pole weight	EPA 70	EPA 80	EPA 90	EPA 100	EPA 110	EPA 120
10 ft.	11 gauge	4x4 in.	11 in.	8-11 in.	2.75 in.	3/4x17x3in.	40 lbs.	25.2	20.5	17.1	11.4	10.3	9.6
15 ft.	11 gauge	4x4 in.	11 in.	8-11 in.	2.75 in.	3/4x17x3in.	54 lbs.	15.2	12.5	10.1	8.5	6.9	5.4
20 ft.	11 gauge	4x4 in.	11 in.	8-11 in.	2.75 in.	3/4x17x3in.	68 lbs.	9.2	7.3	6	4.2	3	1.6
25 ft.	11 gauge	4x4 in.	11 in.	8-11 in.	2.75 in.	3/4x17x3in.	82 lbs.	8.9	6.9	5.7	4.1	3.6	2.2
30 ft.	11 gauge	5x5 in.	11 in.	10-12 in.	3.375 in.	3/4x17x4in.	119 lbs.	7.2	5.4	4.1	3.8	2.8	1.2

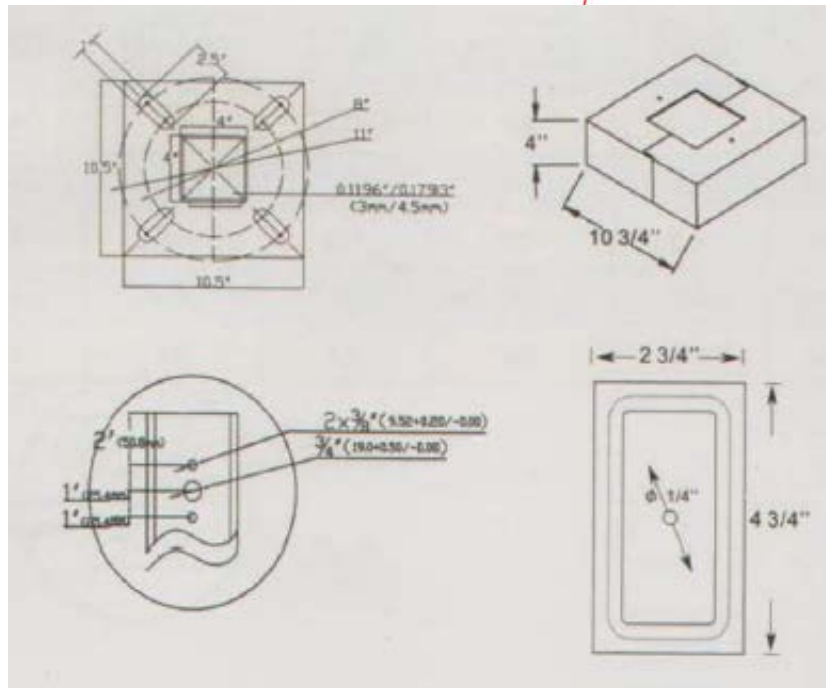



i-LUMINOSITY
LED LIGHTING FIXTURES

Date:	_____
Project:	_____
Price:	_____

National Wind Velocity Map

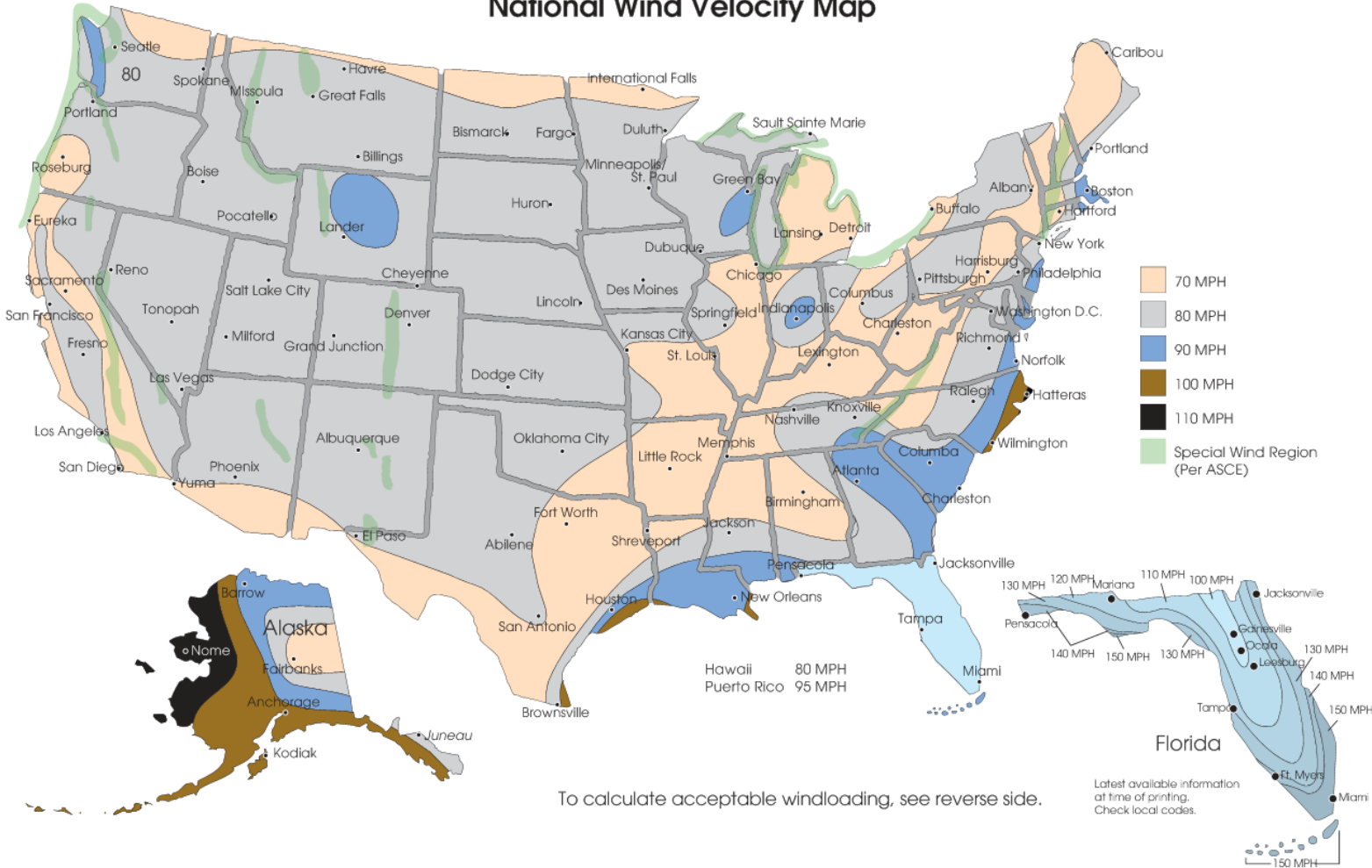

To calculate acceptable windloading, see reverse side.

Latest available information at time of printing. Check local codes.



Date: _____
 Project: _____
 Price: _____

POLE BRACKET • For mounting one fixture on an existing pole

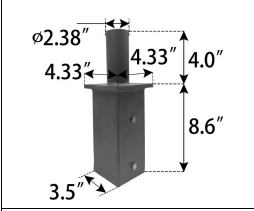
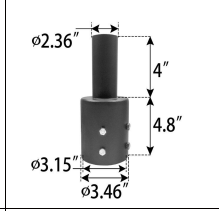
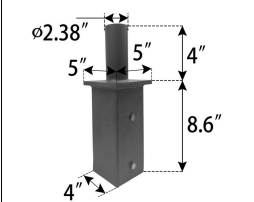
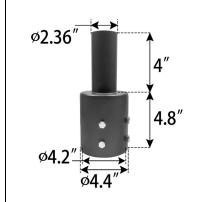
	<p>4\" Square Pole Mount with 2-3/8\" O.D. Tenon Finish: Dark Bronze MAX EPA: 1.2 USE: For use with square, non-tapered steel and aluminum poles. Furnished with four 5/16\" hex head stainless-steel bolts. Vertical tenon measures 2-3/8\" O.D., and is made of steel tubing.</p>		<p>3\" Round Pole Mount with 2-3/8\" O.D. Tenon Finish: Dark Bronze MAX EPA: 1.2 USE: For use with Round, non-tapered steel and aluminum poles. Furnished with three 3/8\" hex head stainless-steel bolts. Vertical tenon measures 2-3/8\" O.D., and is made of steel tubing. Fixtures mounted to this bracket can be adjusted both vertically and horizontally.</p>
	<p>5\" Square Pole Mount with 2-3/8\" O.D. Tenon Finish: Dark Bronze MAX EPA: 1.2 USE: For use with square, non-tapered steel and aluminum poles. Furnished with four 5/16\" hex head stainless-steel bolts. Vertical tenon measures 2-3/8\" O.D., and is made of steel tubing. Fixtures mounted to this bracket can be adjusted both vertically and horizontally.</p>		<p>4\" Round Pole Mount with 2-3/8\" O.D. Tenon Finish: Dark Bronze MAX EPA: 1.2 USE: For use with Round, non-tapered steel and aluminum poles. Furnished with three 3/8\" hex head stainless-steel bolts. Vertical tenon measures 2-3/8\" O.D., and is made of steel tubing. Fixtures mounted to this bracket can be adjusted both vertically and horizontally.</p>

WALL BRACKET

- Attaches to any flat surface
- Provides wiring access

MID-POLE TENON BRACKET

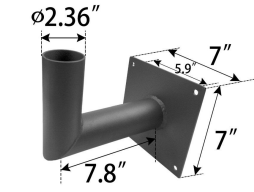
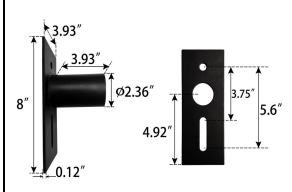
	<p>90\" Wall Mount Bracket with 2-3/8\" O.D. Tenon Finish: Dark Bronze MAX EPA: 1.2 USE: The 90\" wall mount bracket with 2-3/8\" tenon attaches flood and area fixtures to almost any surface: wall, roof, or wood pole. Provides wiring access and a built-in 2-3/8\" O.D. tenon to mount a fixture with our adjustable slip-fitter. Suggested 3/8\" diameter bolts for mounting. Mounting holes are spaced 3-1/4\" apart.</p>		<p>2-3/8\" OD Horizontal Tenon Mid-Pole Bracket Finish: Dark Bronze USE: 2-3/8\" OD Horizontal Tenon Mid-Pole Bracket is designed to mount light fixture that is equipped with an adjustable slip-fitter onto a 2-3/8\" OD horizontal tenon</p>
--	--	--	--

ROUND EXTERNAL MOUNT HORIZONTAL TENON • To mount 2/3/4 fixtures on an existing pole

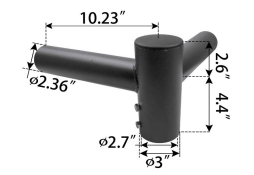
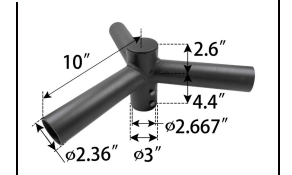
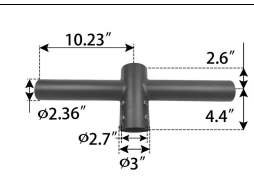
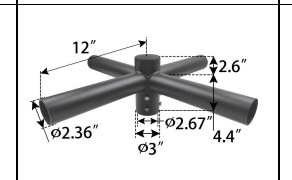
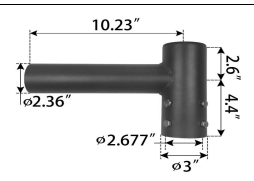
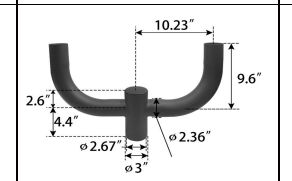
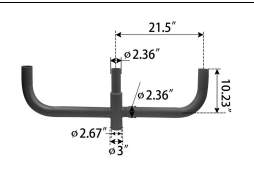
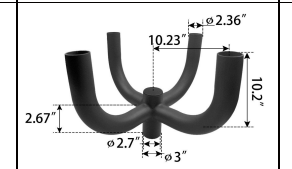
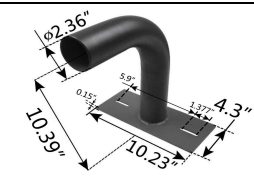
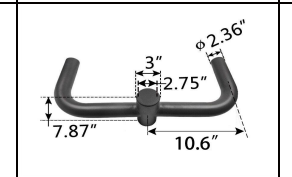
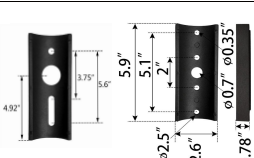
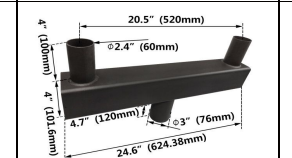
	<p>Double 90\" Horizontal Tenon Adaptor Finish: Dark Bronze MAX EPA: 2.4 USE: The Bracket is designed to mount over 2-3/8\" (60mm) O.D. vertical tenon. Two fixtures can be mounted to the Round External Mount Horizontal Tenon and adjusted horizontally</p>		<p>Triple 120\" Horizontal Tenon Adaptor Finish: Dark Bronze MAX EPA: 3.6 USE: The Bracket is designed to mount over 2-3/8\" (60mm) O.D. vertical tenon. Three fixtures can be mounted to the Round External Mount Horizontal Tenon and adjusted horizontally</p>
	<p>Double 180\" Horizontal Tenon Adaptor Finish: Dark Bronze MAX EPA: 2.4 USE: The Bracket is designed to mount over 2-3/8\" (60mm) O.D. vertical tenon. Two fixtures can be mounted to the Round External Mount Horizontal Tenon and adjusted horizontally</p>		<p>Quad 90\" Horizontal Tenon Adaptor Finish: Dark Bronze MAX EPA: 4.8 USE: The Bracket is designed to mount over 2-3/8\" (60mm) O.D. vertical tenon. Four fixtures can be mounted to the Round External Mount Horizontal Tenon and adjusted horizontally</p>
	<p>Single Spoke Bracket Tenon Adaptor Finish: Dark Bronze MAX EPA: 1.2 USE: The Bracket is designed to mount over 2-3/8\" (60mm) O.D. vertical tenon. One fixture can be mounted to the Round External Mount Horizontal Tenon and adjusted horizontally</p>		<p>Double 180\" Horizontal Tenon Adaptor Finish: Dark Bronze MAX EPA: 2.4 USE: The Bracket is designed to mount over 2-3/8\" (60mm) O.D. vertical tenon. Two fixtures can be mounted to the Round External Mount Horizontal Tenon and adjusted horizontally</p>
	<p>Triple 180\" Horizontal Tenon Adaptor Finish: Dark Bronze MAX EPA: 2.5 USE: The Bracket is designed to mount over 2-3/8\" (60mm) O.D. vertical tenon. Three fixtures can be mounted to the Round External Mount Horizontal Tenon and adjusted horizontally</p>		<p>Quad 90\" Horizontal Tenon Adaptor Finish: Dark Bronze MAX EPA: 4.8 USE: The Bracket is designed to mount over 2-3/8\" (60mm) O.D. vertical tenon. Four fixtures can be mounted to the Round External Mount Horizontal Tenon and adjusted horizontally</p>
	<p>90\" Wall Mount Bracket with 2-3/8\" O.D. Tenon Finish: Dark Bronze MAX EPA: 1.2 USE: The 90\" wall mount bracket with 2-3/8\" tenon attaches flood and area fixtures to almost any surface: wall, roof, or wood pole. Provides wiring access and built-in 2-3/8\" O.D. tenon to mount a fixture with our adjustable slip-fitter. Suggested 3/8\" diameter bolts for mounting. Mounting holes are spaced 3-1/4\" apart.</p>		<p>Double 180\" Horizontal Tenon Adaptor Finish: Dark Bronze MAX EPA: 2.4 USE: The Bracket is designed to mount over 2-3/8\" (60mm) O.D. vertical tenon. Two fixtures can be mounted to the Round External Mount Horizontal Tenon and adjusted horizontally</p>
	<p>Arm Square tube turn tube Tenon Adaptor Finish: Dark Bronze USE: square tube light bar installation, with Arm installation of lamps.</p>		<p>Low Profile Bullhorn with 2 Tenons MAX EPA: 2.3 Weight: 20 lbs Finish: Dark Bronze USE: The Bracket is designed to mount over 2-3/8\" O.D. vertical tenon. Two fixtures can be mounted to the Round External Mount Horizontal Tenon and adjusted horizontally</p>

Date:	_____
Project:	_____
Price:	_____

MOUNTING OPTIONS:

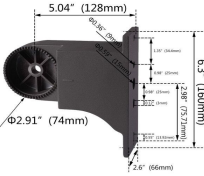
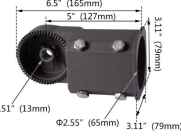
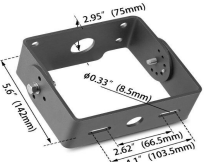
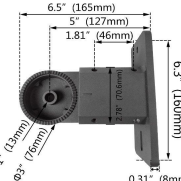
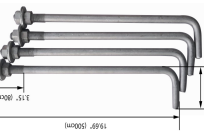
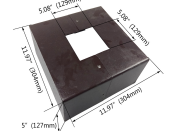
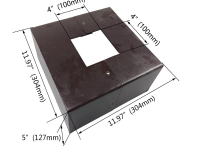
	<p>Finish: Dark Bronze Arm Mount 4" and 5" Square and Round poles. Standard versatile mounting arm is simple to install and can be used with existing poles for retro installations.</p>		<p>Finish: Dark Bronze Slipfitter Mount An optional cast aluminum mast arm adapter secures fixture head to nominal 2"(2-3/8" O.D. pipe size) horizontal steel tenon arm.</p>
	<p>Finish: Dark Bronze Easy to install for direct wall mounting with 1/2" conduit wiring.</p>		<p>Finish: Dark Bronze SFARM2 Mount An optional cast aluminum mast arm adapter secures fixture head to nominal 2"(2-3/8" O.D. pipe size) horizontal steel tenon arm.</p>
	<p>Base Mounting Screw Weight: 10 lbs Finish: Silver Before installing the lamp pole, the installation hook should be buried underground and fixed by cement. After fixing, the lamp pole should be fixed by locking screw and base installed.</p>		<p>Install Base Shield Weight: 10 lbs Finish: Dark Bronze The 5" installation of base shield is used to protect the base after fixing the lamp pole, so that the lamp pole base is not damaged, thereby increasing the service life of the lamp pole.</p>
	<p>Install Base Shield Weight: 10 lbs Finish: Dark Bronze The 4" installation of base shield is used to protect the base after fixing the lamp pole, so that the lamp pole base is not damaged, thereby increasing the service life of the lamp pole.</p>		